



S Series and S200 Series

Tubular and interconnected locks





Contents

4-5	S Series and S200 Series introduction
6-7	S Series performance features and exploded view
8-9	S Series lever designs, lever finishes and door handing
10	S Series lock functions
11	Cylinders and key systems
12	Standard cylinders, full size interchangeable core and Primus XP high security cylinders
13	Interchangeable core conversion kits
14-15	Latches, strikes and rabbeted latch and strike kit
16	S Series specifications, certifications
18-19	S200 Series performance features and exploded view
20	S200 Series lever designs
21	S200 Series lever finishes and door handing
22	S200 Series lock functions
23	Cylinders and key systems
24	Standard cylinders and Primus high security cylinders
25	Interchangeable core, cores and IC cylinders and parts
26	S200 Series latches and deadbolts, door reinforcement and strikes
27	S200 Series specifications, certifications

Pictured here: S Series Saturn lever shown in 626 satin chrome

Cover photo: S Series Jupiter lever shown in 626 satin chrome

Put your trust in the name you know

For more than 90 years, Schlage® has been creating the strongest and most technologically advanced security products for schools, hospitals, hotels, commercial and institutional buildings, multi-family properties and homes. From durable mechanical locks to comprehensive electronic access control solutions and biometrics, Schlage provides protection at critical moments – when property and personal security are at stake. With a wide range of products, styles and finishes, Schlage has products for the most demanding project specifications. In public buildings, in the workplace, and in homes, at the end of the day Schlage stands for one thing: strong.



Real security is knowing exactly what you want and getting it

When you know exactly what you want, you don't want to waste time finding out whether it meets your project specifications. That's why we offer the world's largest team of hardware specification writers to help you and your clients turn your vision into reality. And when it comes to products, our commercial suiting options, wide variety of lever designs and rich selection of finishes give you the tools you need to make your projects perfect. You know what you want. With Schlage, you can be sure you'll get it.

Safety, security and confidence

When you choose a Schlage lock, you can be sure you've done the job right, the first time. After all, our products are among the most durable and dependable on the market today. Our locks are easy to install, and simple to repair and maintain. That means fewer callbacks for you and total safety and security for your customers.



S Series and S200 Series

Smart security for light commercial and multi-family applications

At Schlage, we know that every product you specify has to stand up to constant use, while meeting your needs for security at every level.

Our S Series and S200 Series locks are designed to deliver constant, reliable performance in light commercial applications like small hotels, laboratories and office tenant spaces, as well as apartment buildings.

We don't compromise on security

The safety and security of your clients' buildings is something we take very seriously. That's why every Schlage lock and deadbolt undergoes intensive testing to determine its ANSI grade level:

- Cycle tests
- Resistance tests
- Door impact tests
- Warped door tests
- Bolt strength tests

We pay attention to these details so you can focus on creating a functional and aesthetically pleasing environment for your clients. In fact, every one of our S Series locks meets ANSI Grade 1 standards for safety.

Pictured here: S Series Flair level shown in 626 satin chrome



S Series

Schlage S Series levers are engineered for long life and optimum durability. Easy to install, service and maintain, an S Series lever can help you keep people and property secure.

Pictured here: S Series Neptune lever shown in 626 satin chrome



Built tough from the inside out

- Heat-treated steel locking components for extra strength
- Independent heavy-duty lever torsion springs for durability and long life
- Everest 29™ patented keys standard for commercial applications

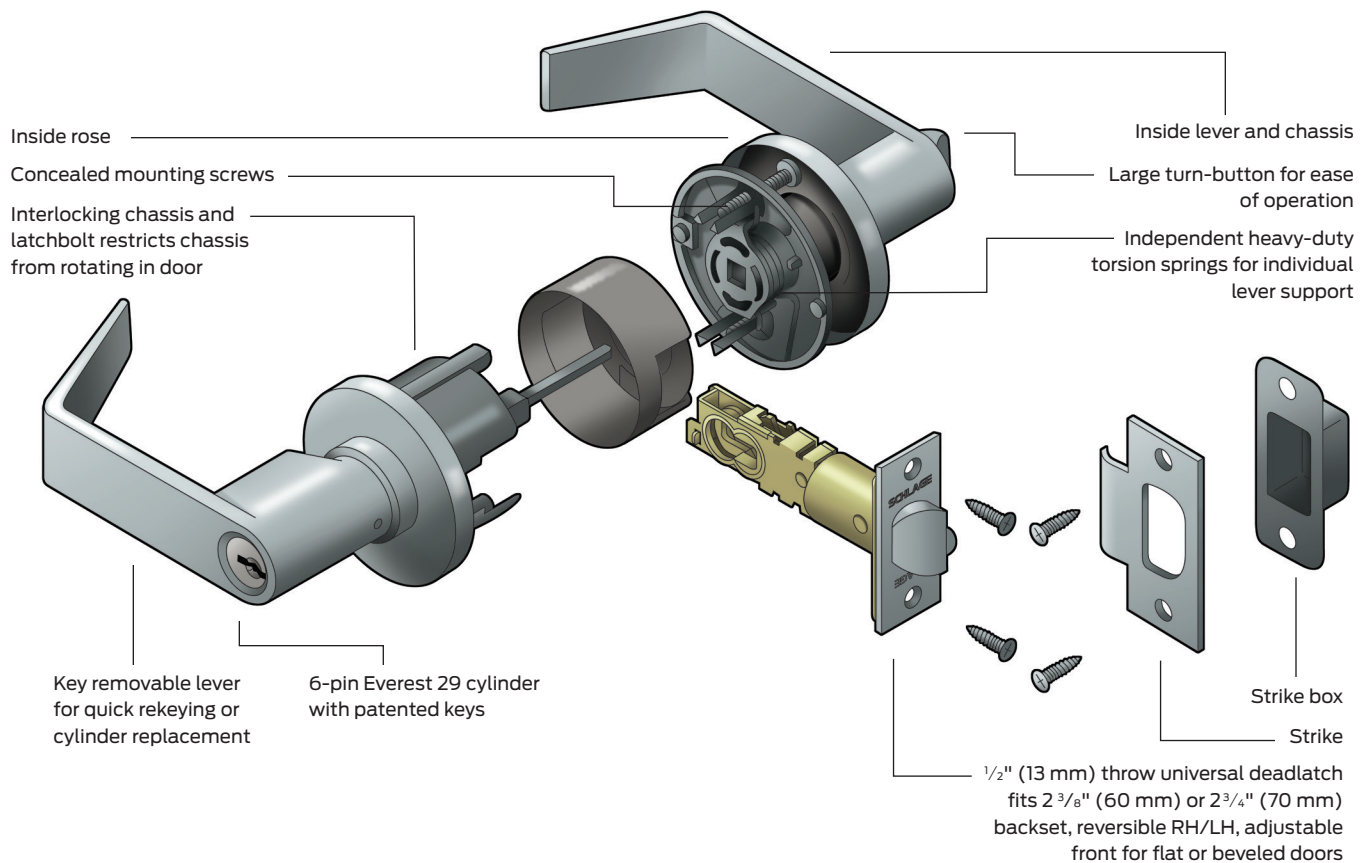

S Series lever designs

Jupiter (JUP)



Symbol: JUP
Material: Pressure cast zinc



Neptune (NEP)



Symbol: NEP
Material: Pressure cast zinc



Saturn (SAT)



Symbol: SAT
Material: Pressure cast zinc



Flair (FLA)



Symbol: FLA
Material: Pressure cast zinc



Tactile warning

Milled

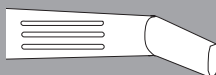

Order as follows:
BSA for Saturn



Only available on outside lever, unless otherwise specified

All designs shown in 626 satin chrome

= Standard cylinder.	= Meets California code for 1/2" or less return to the door.
= FSIC full size interchangeable core option.	= Extended factory lead time.
= Complies with ADA accessibility guidelines.	

Lever finishes

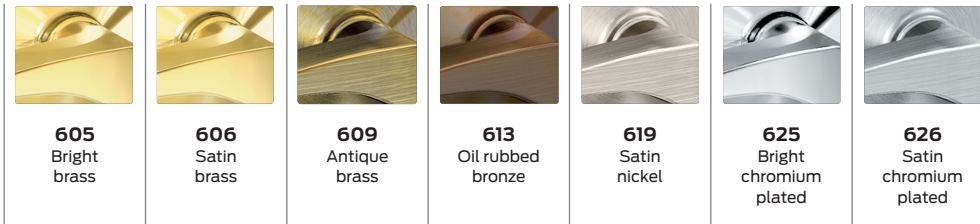

S Series locks							
Flair	•	•	•	•	•	•	•
Jupiter	•	•		•	•	•	•
Neptune	•	•		•	•	•	•
Saturn	•	•	•	•	•	•	•

Door handing

With the exception of the Flair lever design, the S Series lock is reversible. Hand information is necessary to ensure proper cylinder orientation in keyed functions, and finish of latchbolt and strike for locks that are to be installed on reverse bevel doors. Follow the diagram to correctly determine the hand of the door.

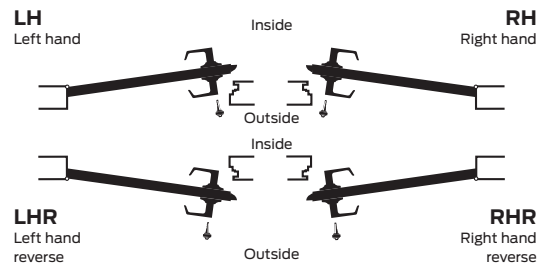

ADA-compliant products

In compliance with the American National Standards Institute (ANSI A117.1) and the Americans with Disabilities Act (ADA), Schlage Lock Company offers a wide selection of locks designed for the needs of the physically challenged. This act is designed to provide protection for people with disabilities.

Product information and specifications contained in this catalog are subject to change without notice. Please consult the factory.

S Series lock functions

ANSI A156.2 Series 4000 Grade 2

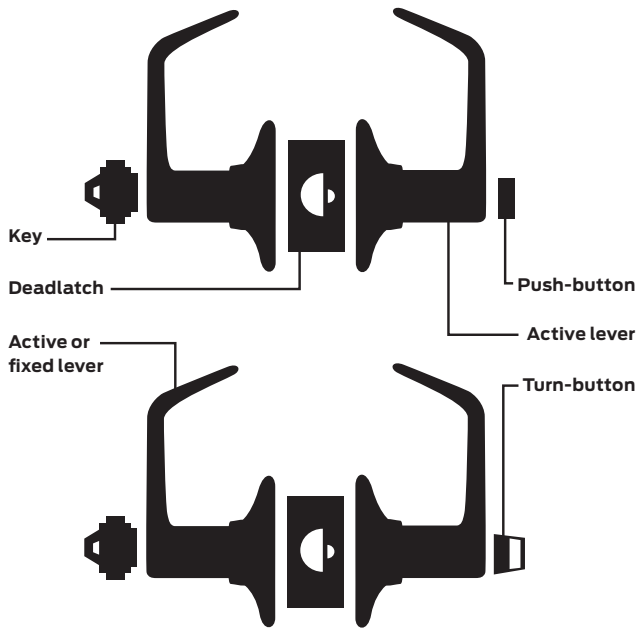
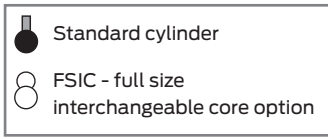

Non-keyed functions

Schlage **S10D** ANSI **F75**

Passage latch

- Both levers always unlocked

Outside Inside

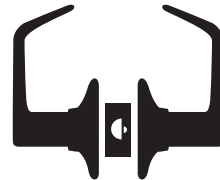

Schlage **S40D** ANSI **F76**

Bath/bedroom privacy lock

- Push-button locking
- Can be opened from outside with small narrow tool
- Turning the inside lever releases button

Outside Inside

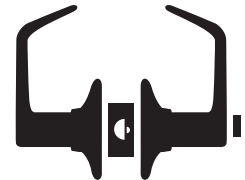

Keyed functions

Schlage **S170** ANSI **-**

Single dummy trim

- Dummy trim for one side of door
- Used for door pull or as matching inactive trim

Outside/Inside



Schlage **S70PD** ANSI **F84**

Classroom lock

- Outside lever locked and unlocked by key
- Inside lever always unlocked

Outside Inside

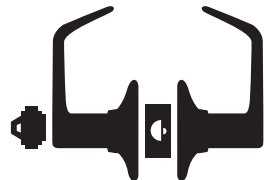

Schlage **S80PD** ANSI **F86**

Storeroom lock

- Outside lever fixed
- Entrance by key only
- Inside lever always unlocked

Outside Inside

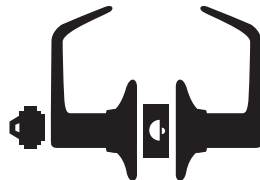

Schlage **S51PD** ANSI **F81**

Entrance lock

- Outside lever locked and unlocked by key or by turn-button on inside lever
- Inside lever always unlocked

Outside Inside

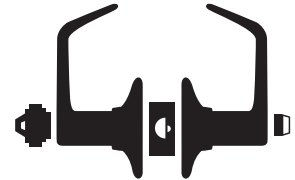

Standard cylinders

Standard cylinders are available in Classic keyways or in patented Everest 29 keyways. Specify keyway to differentiate between Everest 29 and Classic. Example: C (Classic) vs. S123 (Everest 29).

Cylinders for keyed levers - options

- 6-pin conventional cylinder (standard)
- Primus high security cylinder
- Primus UL437 Listed high security cylinder

Available in 606 and 626 finish only.
Everest 29 S123 keyway standard for commercial; C keyway standard for residential.

Sleeve S605-192 included.

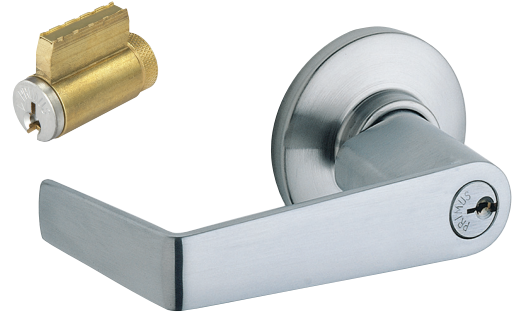
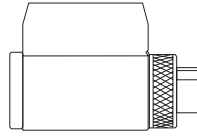

New Everest SL cylinder

- A full-size KIL cylinder that pins to the Schlage SFIC keyways
- Uses pick resistant L pins
- SFIC system owners can gain geographic exclusivity with Primus XP
- Achieves about 57,000 more combinations than a 6-pin system

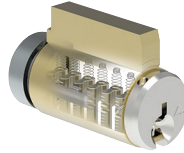

Everest SL cylinder

Full size interchangeable core

Schlage interchangeable core (IC) locksets allow immediate rekeying at the door simply by using the special control key to replace the core in seconds.

FSIC locksets are available in Jupiter, Neptune and Saturn designs.

Full size interchangeable cores - options

(for JD suffix locksets)

- Conventional core
- Primus high security core

Available in 606 and 626 finish only.
Everest 29 S123 keyway standard for commercial; C keyway standard for residential.

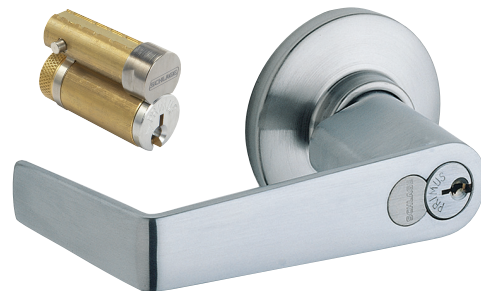

Full size interchangeable cores can be integrated into any 5 or 6-pin Schlage key system with no adverse effects on keying capacity.

Interchangeable core conversion kits

It is easy to convert standard S Series locksets to accept Schlage full size interchangeable cores by changing the lever and adding the parts shown.

Interchangeable core components - options

- Lever, driver, plug, retainer*
- Lever only*
- Retainer
- Driver
- IC installation tool

* Specify design and finish.

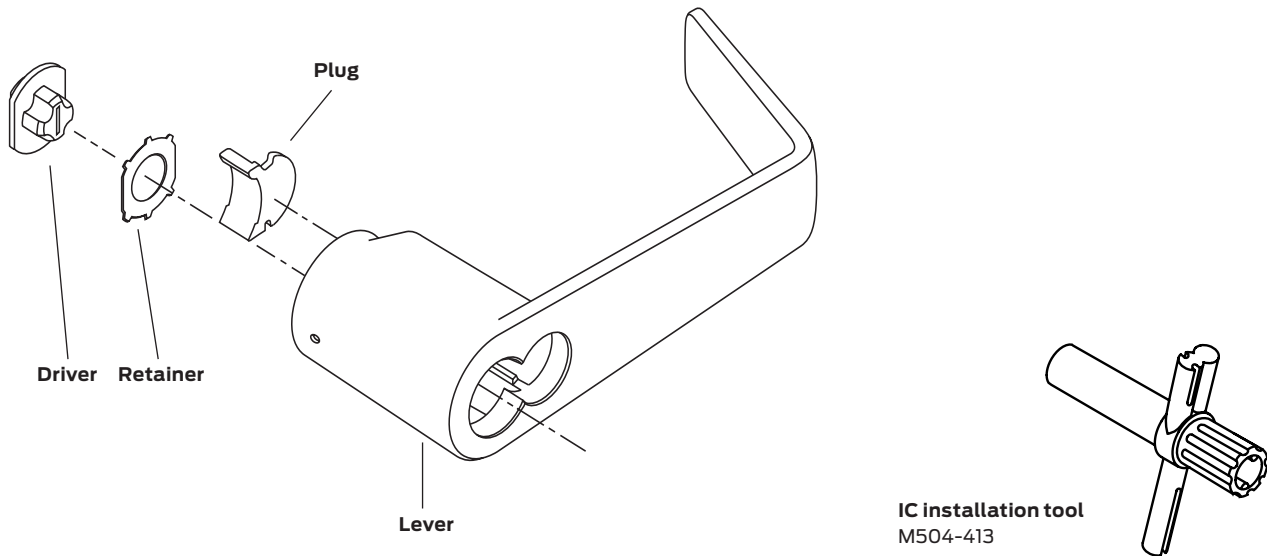

Latches

The standard universal backset deadlatch fits both $2\frac{3}{8}$ " (60 mm) and $2\frac{3}{4}$ " (70 mm) backsets. They are adjustable for flat or beveled edge doors and have a $\frac{1}{2}$ " (13 mm) throw. Orders for complete locks are provided with a G506-815 sleeve for $\frac{7}{8}$ " diameter latches installed in doors with 1" (25 mm) edge bore. All latches have 1" x $2\frac{1}{4}$ " (25 mm x 57 mm) square corner fronts. Standard latches are shown in bold type.

Note: Failure to use the below referenced latches and fire cup, included with the lockset, will invalidate the UL Listing.

Deadlatches - options

Backset	Faceplate description	Hsg dia
$2\frac{3}{8}$ " or $2\frac{3}{4}$ "	1" x $2\frac{1}{4}$" Square corner*	$\frac{7}{8}$ "
	1" x $2\frac{1}{4}$ ", $\frac{1}{4}$ " Radius round corner	$\frac{7}{8}$ "
5"	1" x $2\frac{1}{4}$ " Square corner*	$\frac{7}{8}$ "

*Latches include A501-878 faceplate adapter for $1\frac{1}{8}$ " face.

Square corner deadlatch
16-203

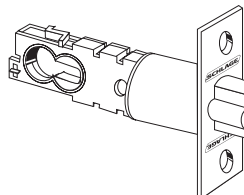

Round corner deadlatch
16-204

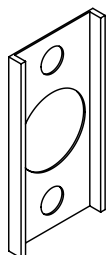
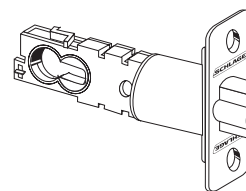

Latch front adapter
A501-878

Used to adapt 1" (25 mm) wide square front faceplates to $1\frac{1}{8}$ " (29 mm) wide door preparations. Furnished in black plastic. Order in multiples of 100.

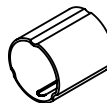

Sleeve
G506-815

Used on $\frac{7}{8}$ " (22 mm) diameter latch housings in 1" (25 mm) edge bore. Furnished standard with complete locks.

Door Reinforcement

Schlage reinforcing units help prevent the collapse of hollow metal doors when locksets are tightly mounted.



A501-566
 $1\frac{3}{4}$ " (44 mm) doors

A501-565
 $1\frac{3}{8}$ " (35 mm) doors

Strikes

All Schlage strikes are furnished complete with screws. The 10-001 standard S Series strike has a 1 1/8" (29 mm) lip. When ordering separately, specify quantity, product number, finish, and lip length. Standard strike is shown in bold type.

Strikes - options

- 1", 1 1/8" (**Std**), 1 1/4", 1 1/2", 1 3/4", 2" (25 mm, 29 mm, 32 mm, 38 mm, 44 mm, 51 mm) - 1 1/8" x 2 3/4" (29 mm x 70 mm) square corner, standard
- 1 1/8" (29 Mm) - 1 1/8" x 2 3/4" (29 mm x 70 mm) 1/8" (3 mm) radius, round corner
- 1 3/16", 1 3/8" (30 mm, 35 mm) - 1 1/4" x 4 7/8" (32 mm x 124 mm) ANSI
- 1 1/8" (29 mm) - 1 5/8" x 2 1/4" (41 mm x 57 mm) full lip, square corner
- 1 1/8" (29 mm) - 1 5/8" x 2 1/4" (41 mm x 57 mm) full lip, 1/4" (6 mm) radius, round corner
- Box, ANSI

T-strike – standard

10-001
1 1/8" x 2 3/4" x 3/32"
(29 mm x 70 mm x 2 mm)

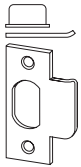

ANSI strike

10-025
1 1/4" x 4 7/8" x 3/32"
(32 mm x 124 mm x 2 mm)



Full lip - square corner

10-026
1 5/8" x 2 1/4" x 3/32"
(41 mm x 57 mm x 2 mm)

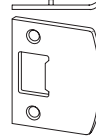

Full lip - round corner

10-027
1 5/8" x 2 1/4" x 3/32"
(41 mm x 57 mm x 2 mm)

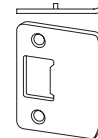

Rabbeted latch and strike kit

Rabbeted latch and strike kit finishes: 605, 626.

This kit adapts square corner latches and strikes for 1/2" (13 mm) rabbeted door and frame preparations.

Rabbeted latch and strike kit

39-030

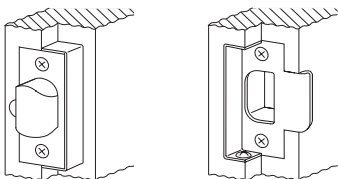

Specifications

Handing:

Not handed, except Flair design.

Door thickness:

1³/₈" to 2" (35 mm-51 mm) except S40D: 1³/₈" to 1⁷/₈" (35 mm-48 mm)

Backset:

Universal backset latches standard, fit either 2³/₈" (60 mm) or 2³/₄" (70 mm). 5" (127 mm) optional.

Fronts:

Steel. 1" x 2¹/₄" (25 mm x 57 mm) square corner, beveled, for 2³/₄" backset standard.

Lock chassis:

Tubular construction. Zinc with steel cover.

Latch bolt:

Brass, chrome plated, 1/2" (13 mm) throw, deadlocking.

Exposed trim:

Levers are zinc base, plated to match finish symbols. Roses, latch faceplates and strikes are wrought brass or bronze.

Strike:

T-strike 1¹/₈" x 2³/₄" (29 mm x 70 mm) x 1¹/₈" (29 mm) lip to center with box standard. Optional strikes, lip lengths and ANSI strike box available.

Cylinder and keys:

Commercial: 6-pin patented Everest 29 S123 keyway standard with two nickel silver keys per lock.
Residential: 6-pin C keyway, keyed 5-pin.

Keying options:

Interchangeable core available, for Primus Xp cylinder, order locks less cylinder and order Primus Xp cylinder separately. Master keying, grand master keying, and construction keying.

Warranty:

Commercial: Three-year limited.

Certifications

ANSI

Meets or exceeds A156.2 Series 4000, Grade 2 strength and operational requirements.

Federal:

Meets FF-H-106C.

California State Reference Code:

(Formerly Title 19, California State Fire Marshal Standard)

All levers with a return to door of 1/2" (64mm) or less comply.

UL / cUL:

All locks listed for A label single doors, 4' x 8'. Letter F and UL symbol on latch front indicate listing. UL437 Listed locking cylinder optional: specify less cylinder and order Primus 20-500 Series cylinder separately.

ADA compliant:

Schlage Lock Company offers a wide selection of locks designed to meet the Americans With Disabilities Act.

S200 Series

When it comes to quick, easy egress and dependable security, Schlage S200 Series interconnected locks get the job done. Designed for applications ranging from military housing to multi-family and small hotel/motel buildings, the S200 Series is a lock you can depend on.

Pictured here: S200 Series interconnected lock with Flair lever in 626 satin chrome



Safety, security and long-lasting performance

- Heat-treated steel locking components for extra strength
- Independent heavy-duty lever torsion springs for durability and long life
- Non-handed levers for easy field installation
- Extra-strong Everest 29™-patented keys standard for commercial applications

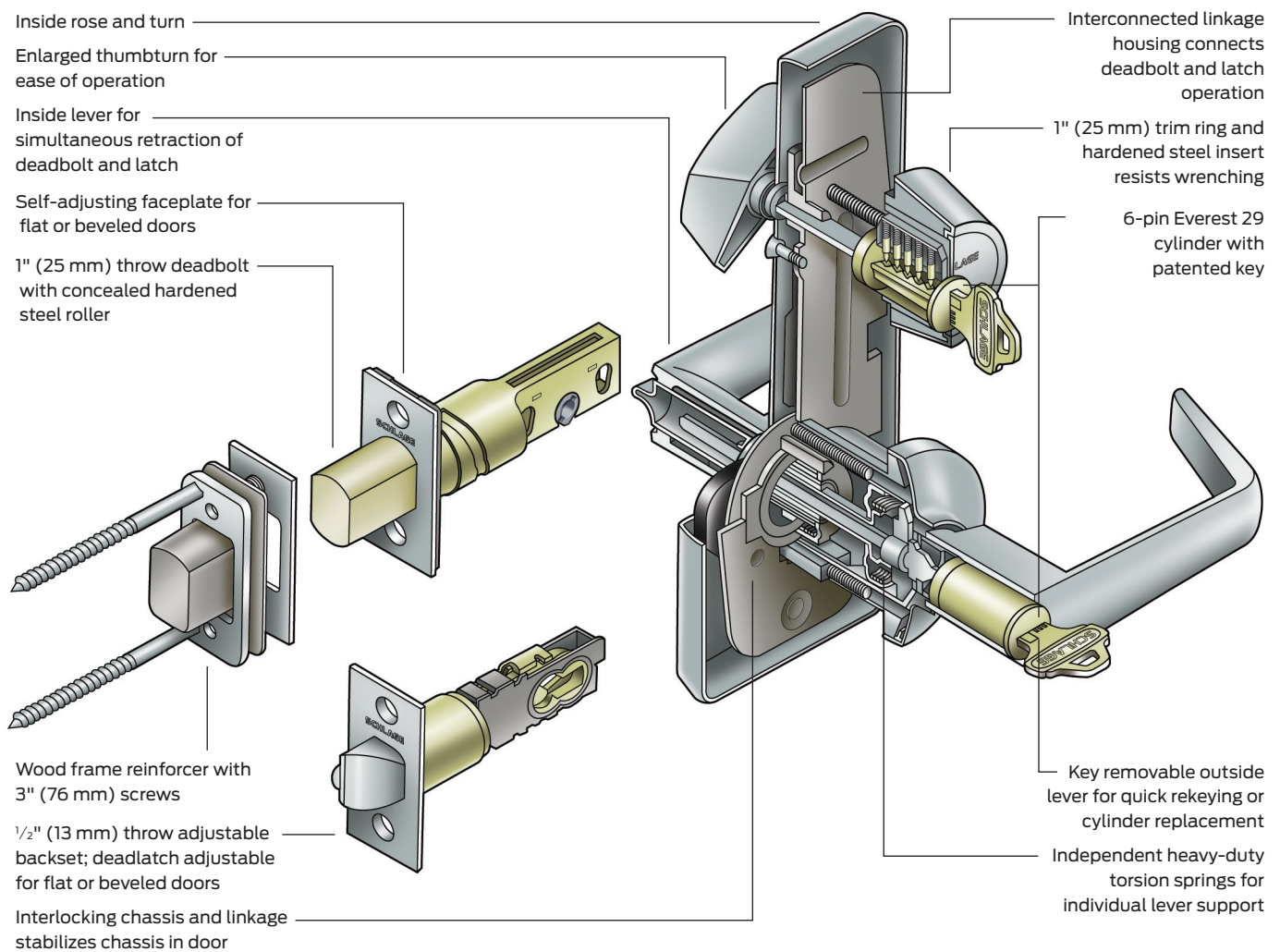

S200 Series lever designs

Flair (FLA)

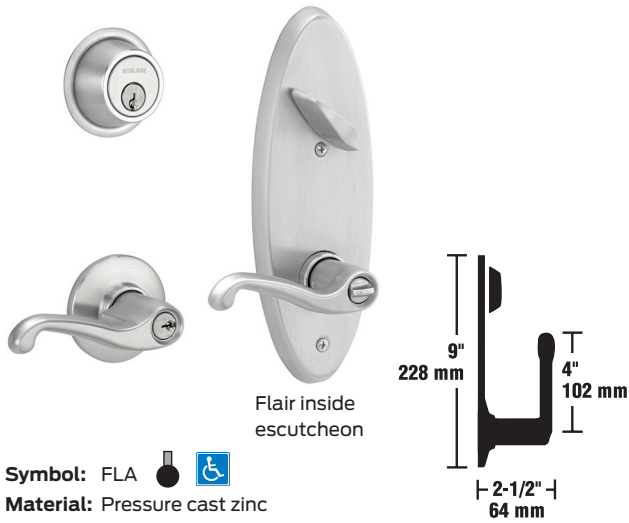

Neptune (NEP)

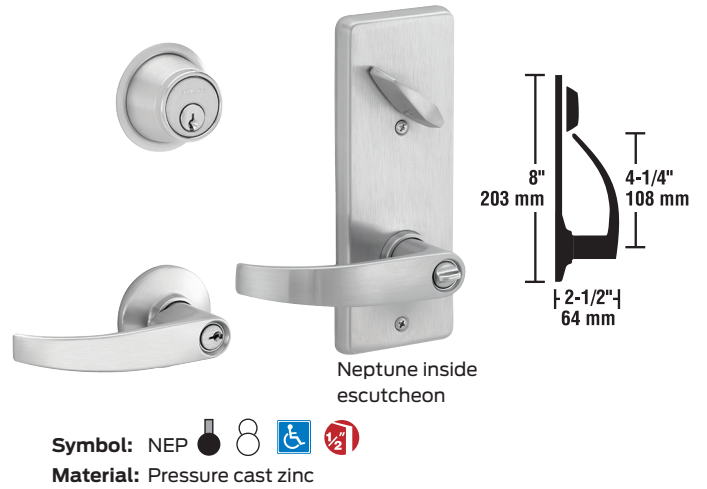

Saturn (SAT)



Jupiter (JUP)

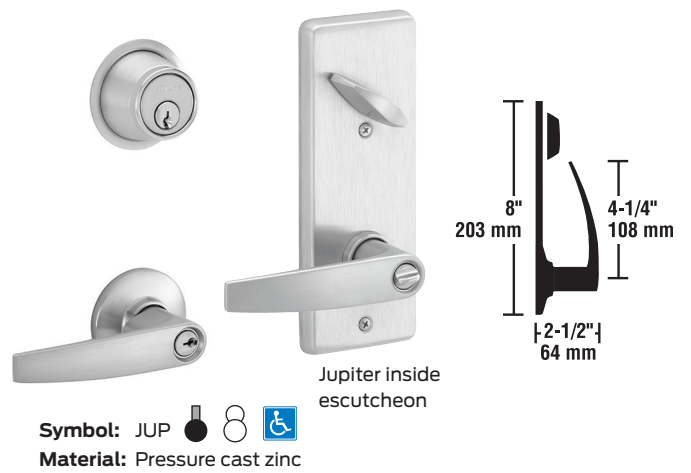

Meteor outside escutcheon







3 1/4" x 8 1/4" x 3/16"

Order separately

Material: Pressure cast zinc

All designs shown in 626 Satin Chrome

-  = Standard cylinder.
-  = FSIC full size interchangeable core option.
-  = Complies with ADA accessibility guidelines.
-  = Meets California code for 1/2" or less return to the door.

Lever finishes

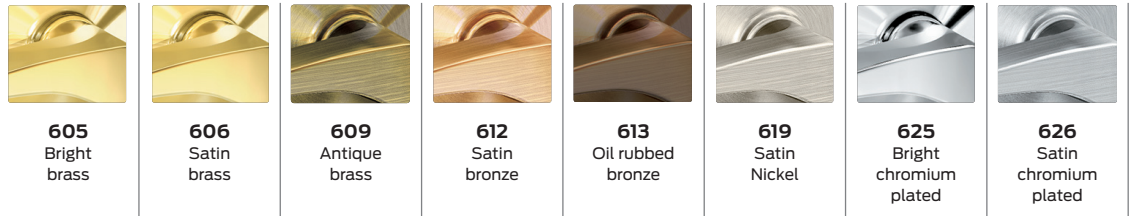

S200 Series locks	605 Bright brass	606 Satin brass	609 Antique brass	612 Satin bronze	613 Oil rubbed bronze	619 Satin Nickel	625 Bright chromium plated	626 Satin chromium plated
Flair	•	•	•	•	•	•	•	•
Jupiter	•	•			•	•	•	•
Neptune	•	•			•	•	•	•
Saturn	•	•	•	•	•	•	•	•
Meteor (36-056)	•	•	•	•	•	•	•	•

Door handing

All Schlage locks are reversible. Hand information is necessary to ensure proper cylinder orientation in keyed functions, and finish of latchbolt and strike for locks that are to be installed on reverse bevel doors. Follow the diagram to correctly determine the hand of the door.

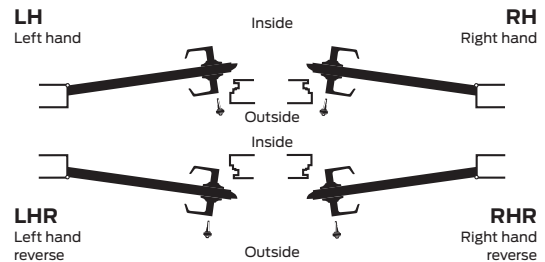

ADA-compliant products





In compliance with the American National Standards Institute (ANSI A117.1) and the Americans with Disabilities Act (ADA), Schlage Lock Company offers a wide selection of locks designed for the needs of the physically challenged. This act is designed to provide protection for people with disabilities.

Product information and specifications contained in this catalog are subject to change without notice. Please consult the factory.

S200 lock functions

ANSI A156.12-1992, Grade 2

	Standard cylinder
	FSIC - full size interchangeable core option
	Safe school locks

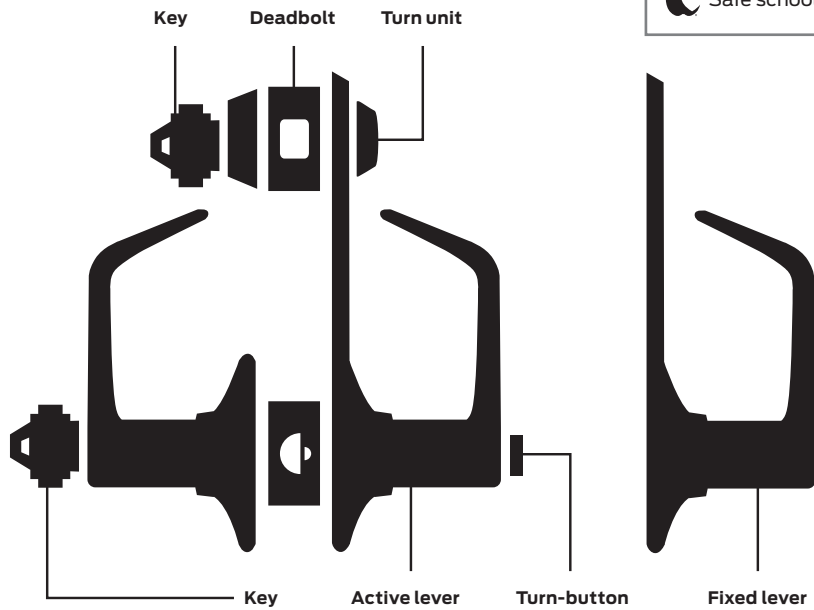

Keyed functions

Schlage **S210PD** ANSI **F95**

Entrance, single locking

- Deadbolt operated by key from outside or by turning unit from inside
- Bolt automatically deadlocks when fully thrown
- Latchbolt retracted by lever from either side
- Turn inside lever to simultaneously retract deadbolt and latchbolt for immediate exit

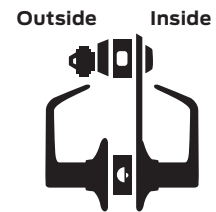

Schlage **S251PD** ANSI **F97**
Entrance, double locking

- Deadbolt operated by key from outside or by turning unit from the inside
- Bolt automatically deadlocks when fully thrown
- Outside lever is unlocked by key from the outside or by turn-button on inside lever
- Turn inside lever to simultaneously released deadbolt and latchbolt for immediate exit
- Latch automatically deadlocks when door is closed

Outside Inside



Schlage **S270PD** ANSI **-**
Classroom lock

- Deadbolt operated by key from outside or by turning unit inside
- Bolt automatically deadlocks when fully thrown
- Outside lever is locked and unlocked by key from the outside
- Turn inside lever to simultaneously retract deadbolt and latchbolt for immediate exit
- Latch automatically deadlocks when door is closed

Outside Inside



Schlage **S280** ANSI **F98**
Storeroom lock

- Deadbolt operated by key from outside or by turning unit from the inside
- Bolt automatically deadlocks when fully thrown
- Outside lever is fixed
- Entrance by key only
- Inside lever simultaneously retracts both latch and deadbolt for immediate exit
- Latch automatically deadlocks when door is closed

Outside Inside

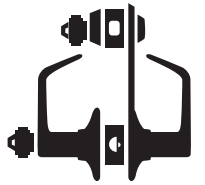

Schlage **S290PD** ANSI **-**
Single dummy trim

- Dummy trim for one side of door
- Used for door pull or as matching inactive trim

Outside/Inside



Cylinders and key systems

Administrative Security		Schlage Everest 29™	
		Schlage Classic	Schlage Everest 29 R
Primus® XP geographically exclusive side bit milling options	End user exclusive nationwide	4N	9N
	End user exclusive within time zone/country	4Z	9Z
	End user exclusive within zip code	3G	9G
	End user controlled; non-exclusive	3U	9U
	Dealer exclusive within time zone/country	2	8
	Dealer exclusive within zip code	1+	7
	Authorized dealer only; non-exclusive	1	

Administrative Security	Physical Security
<p>End user controlled; non-exclusive</p> <p>Authorized dealer only</p> <p>No authorization</p> <p>OPEN Schlage Classic FSIC & Conventional</p> <ul style="list-style-type: none"> Duplicate anywhere 	<p>OPEN Schlage Everest 29 S FSIC & Conventional</p> <ul style="list-style-type: none"> Patented design Check pin in cylinder
<p>RESTRICTED Schlage Everest 29 R SFIC & Conventional*</p> <p>Schlage Everest 29 T FSIC & Conventional</p> <ul style="list-style-type: none"> Requires letter of authorization Patented design Check pin in cylinder 	<p>RESTRICTED Schlage Classic FSIC & Conventional</p> <ul style="list-style-type: none"> 5 levels of side bit milling exclusivity Patent protection to 2024 Independent sidebar and finger pin locking mechanisms
	<p>RESTRICTED Schlage Everest 29 R Conventional*</p> <p>Schlage Everest 29 S FSIC & Conventional</p> <p>Schlage Everest 29 T FSIC & Conventional</p> <ul style="list-style-type: none"> 5 levels of side bit milling exclusivity Patent protection to 2029 Independent sidebar and finger pin locking mechanisms
	<p>UL 437 Option UL listed security improvements available with Primus XP</p> <ul style="list-style-type: none"> Hardened steel drill pins Proven pick and drill resistant Withstands extreme physical attack

COMPARABLE ELECTRONIC SECURITY - Ensure your credential is as secure as your keyway		
<p>Proximity credentials</p> <ul style="list-style-type: none"> Easily duplicated 	<p>MIFARE Classic® smart credentials</p> <ul style="list-style-type: none"> Secure encrypted data & communications Difficult to duplicate 	<p>MIFARE Plus® & MIFARE® DESFire® EV1 smart credentials</p> <ul style="list-style-type: none"> Advanced data encryption makes duplication nearly impossible Most secure credentials available from Schlage

* As SL cylinder that accepts SFIC key

Primus XP access control and high security cylinders

Primus XP access control and high security cylinders are available to add patented key control and varying degrees of geographical exclusivity to most Schlage 6-pin key systems, whether Everest 29 or Classic keyways.

In addition to a conventional pin tumbler mechanism, Primus cylinders incorporate a patented finger pin and sidebar design, providing a “dual-locking” cylinder that is virtually pick-proof. Resistance to drilling and other physical attack is optional by specifying 20-500 Series UL437 Listed cylinders.

Classic Primus XP cylinders are recommended for upgrading existing Classic key systems. Due to its extended patent life, the newly designed Everest 29 Primus XP is recommended for new key systems and for upgrading existing Everest key systems. Specify keyway to differentiate between Everest 29 and Classic. Example: C or CP (Classic) vs. S123 (Everest 29).

Visit allegion.com/us for more information.

Standard cylinders

Schlage locks are provided with cylinders precision built to extremely close tolerances and the highest standards of accuracy. Using only solid brass plugs, extruded brass shells, phosphor bronze springs, nickel silver keys and pins, ensures long life and ease of operation.

Conventional cylinders are available in Classic keyways or in the newly patented Everest 29 keyways. Specify keyway to differentiate between Everest 29 and Classic. Example: C (Classic) vs. S123 (Everest 29).

Cylinders for deadbolt (top) - options

- 6-pin conventional (standard)
- Primus XP high security
- Primus XP UL437 Listed high security

Cylinder only available in 606 and 626 finish only. Cylinder with housing available 605, 606, 609, 612, 613, 625, 626.

Everest 29 S123 keyway standard for commercial; C keyway standard for residential.



Cylinder only

Cylinders for keyed levers (bottom)- options

- 6-pin conventional (standard)
- Primus XP high security cylinder
- Primus XP UL437 Listed high security

Available in 606 and 626 finish only.

Everest 29 S123 keyway standard for commercial; C keyway standard for residential.

Sleeve S605-192 included.

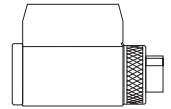

New Everest SL cylinder

- A full-size KIL cylinder that pins to the Schlage SFIC keyways
- Uses pick resistant L pins
- SFIC system owners can gain geographic exclusivity with Primus XP
- Achieves about 57,000 more combinations than a 6-pin system

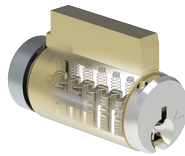

Everest SL cylinder

Interchangeable core 8

Schlage interchangeable core (IC) locksets allow immediate rekeying at the door simply by using the special control key to replace the core in seconds.

IC locksets are available in all designs except Flair.

Full size interchangeable cores can be integrated into any 5 or 6-pin Schlage key with no adverse affects on keying capacity.

To order complete locks with full size cores, change suffix from PD to RD. Example: S251RD. To order locks less core, change suffix to JD. To order with full size construction core, change suffix to TD.

Jupiter
Symbol: JUP
Material: Pressure cast zinc





Neptune
Symbol: NEP
Material: Pressure cast zinc





Saturn
Symbol: SAT
Material: Pressure cast zinc





All designs shown in 626 satin chrome

Cores, and IC cylinders and parts



Full size interchangeable cores - options

- 6-pin conventional (standard)
- Primus high security cylinder

Available in 606 and 626 finish only. Everest 29 S123 keyway standard for commercial; C keyway standard for residential.

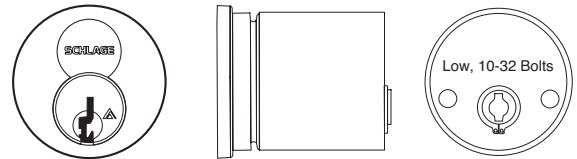

IC cylinders for deadbolt (top) - options

Tailpiece not included.

- Conventional core
- Primus core
- Primus XP core
- Housing less core

Available in 605, 606, 609, 612, 613, 625 and 626 for housing; 606 and 626 for cores and cylinders only.

Everest 29 S123 keyway standard for commercial; C keyway standard for residential.

IC installation tool

This tool is used to install the driver and retainer for full size IC in Schlage knobs and levers. Its other ends are designed to install and remove mortise cylinder housings and test mortise cylinder cam action for both small format and full size interchangeable core cylinders.

M504-413
 (Order separately)

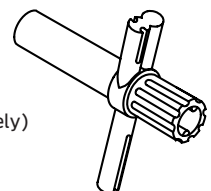

Latches and deadbolts

The standard universal backset deadlatch fits both 2³/₈" (60 mm) and 2³/₄" (70 mm) backsets. They are adjustable for flat or beveled edge doors and have a 1/2" (13 mm) throw. Orders for complete locks are provided with a G506-815 sleeve for 7/8" diameter latches installed in doors with 1" (25 mm) edge bore. Deadbolts have 1" (25 mm) housings and 1" (25 mm) throw. All latches and bolts for the S200 Series have 1¹/₈" x 2¹/₄" square corner fronts.

Note: Failure to use the below-referenced latches and fire cup, which are included with the lockset, will invalidate the UL Listing.

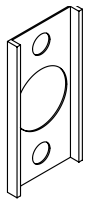

Latch front adapter
A501-878

Used to convert 1" (25 mm) wide squarefront faceplates for 1¹/₈" (29 mm) wide doorpreparations. Furnished in black plastic. Order in multiples of 100.

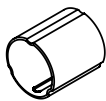

Sleeve
G506-815

Used on 7/8" (22 mm) diameter latch housings in 1" (25 mm) edge bore. Furnished standard with complete locks.

Deadbolt/deadlatch combinations

Backset	Deadbolt	Deadlatch	Combo pair
2 ³ / ₈ " or 2 ³ / ₄ "	12-288	16-480	16-481
5"	12-633	16-132*	16-484

* 5" backset deadlatch includes A501-878 latch front adapter for 1¹/₈" preparation. Specify finish.

Deadbolt (top)
Fixed backset

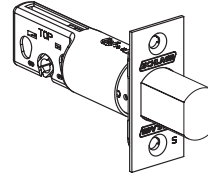

Latch (bottom)
Adjustable backset

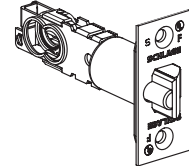

Door reinforcement

Schlage reinforcing units help prevent the collapse of hollow metal doors when locksets are tightly mounted.



A501-565
1¹/₈" (35 mm) doors

A501-566
1³/₄" (44 mm) doors

Strikes

Deadbolt strikes

Part number	Description	Lip length
10-064	Circular drive-in, thimble strike, 1 ³ / ₁₆ " diameter, 494 (for 626 only)	-
10-092	1/4" radius round corner, full lip, no box, 1 ⁵ / ₈ " x 2 ¹ / ₄ "	1 ¹ / ₈ "
10-094	Square corner, box, 1 ¹ / ₈ " x 2 ³ / ₄ " standard	-
10-095	Square corner, full lip, no box, 1 ⁵ / ₈ " x 2 ¹ / ₄ "	1 ¹ / ₈ "

Deadlatch strikes

Part number	Description	Lip length
10-001	Square corner, T-strike, box, 1 ¹ / ₈ " x 2 ³ / ₄ ", standard	1 ¹ / ₈ "
10-026	Square corner, full lip, no box, 1 ⁵ / ₈ " x 2 ¹ / ₄ "	1 ⁷ / ₃₂ "
10-027	1/4" Radius round corner, full lip, no box, 1 ⁵ / ₈ " x 2 ¹ / ₄ "	
10-058	Circular, adjustable, 1 ³ / ₄ " diameter, 605 and 626 only	

Deadbolt/deadlatch strike combinations

Combo number	Deadbolt strike	Deadlatch strike
10-109	10-094	10-001, 1 ¹ / ₈ " lip
10-251	10-064	10-001, 1 ¹ / ₈ " lip
10-110	10-094	10-026
10-253	10-064	10-026
10-111	10-094	10-027
10-256	10-064	10-027
10-257	10-092	10-027
10-258	10-064	10-058
10-259	10-095	10-026

10-064



10-092

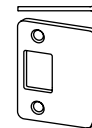

10-094

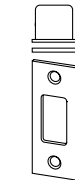

10-095

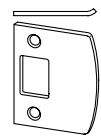

10-001



10-026

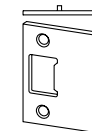

10-027

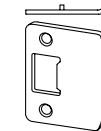

10-058



Specifications

Handing:

Not handed, except Flair design.

Door thickness:

1³/₈" to 2" (35 mm-51 mm).

Backset:

2³/₈" (60 mm) Standard, 2³/₄" (70 mm) and 5" (127 mm) available.

Fronts:

Brass or bronze. 1¹/₈" x 2¹/₄" (29 mm x 57 mm) square corner, beveled, for 2³/₄" backset standard.

For availability with specific backsets, see page 29.

Lock chassis:

Steel, zinc dichromate plated for corrosion resistance.

Deadbolt:

1" (25 mm) throw with hardened steel roller, and 1" (25 mm) housings standard.

Latch bolt:

Brass, chrome plated, 1/2" (13 mm) throw, deadlocking.

Exposed trim:

Levers are zinc base, plated to match finish symbols. Roses, escutcheons, latch faceplates and strikes are wrought brass or bronze.

Strike:

T-strike 1¹/₈" x 2³/₄" (29 mm x 70 mm) x 1¹/₈" (29 mm) lip to center with box standard. Optional strikes, lip lengths and ANSI strike box available.

Cylinder and keys:

Commercial: 6-pin patented Everest 29 S123 keyway standard with two nickel silver keys per lock.

Residential: 6-pin C keyway, keyed 5-pin.

Keying options:

Interchangeable core and Primus high security cylinders. Master keying, grand master keying, and construction keying.

Warranty:

Commercial: Three-year limited.

Certifications

Federal:

Meets FF-H-106C.

California State Reference Code:

(Formerly Title 19, California State Fire Marshal Standard)

All levers with a return to door of 1/2" (64 mm) or less comply.

UL / cUL:

All locks listed for A label single doors, 2' x 8'.

Letter F and UL symbol on latch front indicate listing.

UL437 Listed locking cylinder optional: specify Primus 20-500 Series cylinder.

ADA compliant:

Schlage Lock Company offers a wide selection of locks designed to meet the Americans With Disabilities Act.

Ordering instructions and product detail

S Series

Example													
Line item	Qty	Product	Outside		Inside		Hand	Latch	Strike	Dr thk	Ext	Dim	Additional details
			Des	Fin	Des	Fin							
1	10	S51PD	FLA	626	FLA	613	RH	16-204	10-025	-	-	1316	KA

Line item: Line item number

Qty: Quantity

Product: Product function + cylinder code

Outside des: Outside lever design

Outside fin: Outside finish

Inside des: Inside lever design - Specify only if different from outside lever design

Inside fin: Inside finish - Specify only if different from outside finish

Hand: Hand of door - N/A for A lock

Latch: Product latch - Leave blank for standard latch or specify part number if non-standard latch is required

Strike: Product strike - Leave blank for standard strike or specify part number if non-standard strike is required

Dr thk: Door thickness - Enter door thickness if non-standard (example: 138=1 3/8"; 214=2 1/4")

Ext: Extension - Enter for doors 1 7/8" or greater (example: EE=extended equally; EI=extended inside; EO=extended outside; ED=extended differently)

Dim: Dimension - Enter only for non-standard strike lip length

Additional details: Enter additional detail for keying information or special requirements

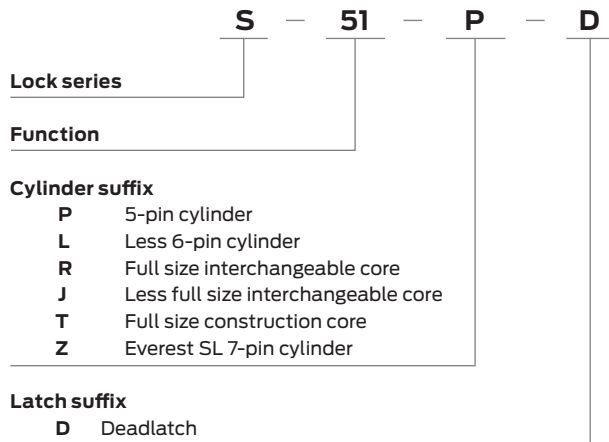

Ordering instructions and product detail

S200 Series

Example													
			Outside		Inside								
Line item	Qty	Product	Des	Fin	Des	Fin	Hand	Latch	Strike	Dr thk	Ext	Dim	Additional details
1	10	S251PD	NEP	626	FLA	613	RH	12-339	10-109	-	-	-	-

Line item: Line item number

Qty: Quantity

Product: Product function + cylinder code

Outside des: Outside lever design

Outside fin: Outside finish

Inside des: Inside lever design - Specify only if different from outside lever design

Inside fin: Inside finish - Specify only if different from outside finish

Hand: Hand of door - N/A for A lock

Latch: Product latch - Leave blank for standard latch or specify part number if non-standard latch is required

Strike: Product strike - Leave blank for standard strike or specify part number if non-standard strike is required

Dr thk: Door thickness - Enter door thickness if non-standard (example: 138=1 3/8"; 214=2 1/4")

Ext: Extension - Enter for doors 1 7/8" or greater (example: EE=extended equally; EI=extended inside; EO=extended outside; ED=extended differently)

Dim: Dimension - Enter only for non-standard strike lip length

Additional details: Enter additional detail for keying information or special requirements

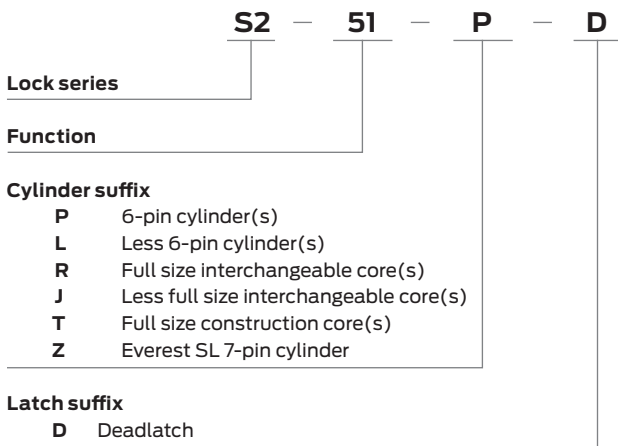

About Allegion

Allegion (NYSE: ALLE) is a global pioneer in safety and security, with leading brands like CISA®, Interflex®, LCN®, Schlage®, SimonsVoss® and Von Duprin®. Focusing on security around the door and adjacent areas, Allegion produces a range of solutions for homes, businesses, schools and other institutions. Allegion is a \$2 billion company, with products sold in almost 130 countries.

For more, visit www.allegion.com

KRYPTONITE ■ LCN ■  ■ STEELCRAFT ■ VON DUPRIN