

9540 SERIES

FEATURES

SINGLE DOOR, SURFACE MOUNT (PUSH) OFFSET PIVOT/BUTT HINGE

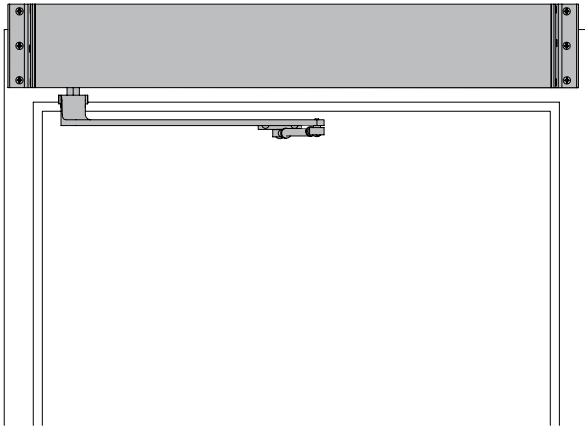

The 9540 SENIOR SWING by LCN is an ADA door operator that is a two-in-one swing door operator. SENIOR SWING operators when activated, opens doors automatically for wheelchair access, yet allows for manual operation for regular pedestrian traffic.

- Push 'N Go permits non-switch activation.
- Power Boost provides additional latching force.
- Electromechanical unit with microprocessor control.
- Digital keypad for easy setup.
- Meets International Building Code requirements and ANSI A156.19.
- UL approved for fire doors.

9540 Series is fully compliant with UL 325 & UL 1998 and meets the provisions of ANSI A156.19. The 9540 Series is UL listed for fire-rated applications. The 9540 Series also meets the provisions of the Americans with Disabilities Act.

- 9540 Series operator is shipped with motor gearbox, control box, regular arm, header, and mounting hardware. Actuators available separately, see pages 122-137.
- Single door, surface mounted.
- Meets ADA requirements (power mode only).
- Handed product.
- 36" header length is standard. Specify length 33" to 48" max.
- Double door header available up to 98", specify other length 49" to 98" max. Consult factory regarding this option.
- Adjustable hold open period of 2 to 32 seconds in automatic or manual mode.

MOUNTING						HANDING		FINISH	COVER	ARM FUNCTION		
●	○	○	○	○	○	●	○	○	○	○	○	○
SURFACE MOUNT SINGLE DOOR						HANDED		STANDARD ANODIZED	COVER	STANDARD (SINGLE LEVER)		
SURFACE MOUNT SIMULTANEOUS PAIR						NON-HANDED		METAL	COVER	REGULAR (DOUBLE LEVER)		
SURFACE MOUNT INDEPENDENT PAIR									COVER	DOUBLE EGRESS (PUSH/PULL)		
CONCEALED SINGLE DOOR									COVER	OFFSET PIVOT (BUTT HINGE ARM)		
CONCEALED SIMULTANEOUS PAIR									COVER	CENTER PIVOT ARM		

● AVAILABLE
○ NOT AVAILABLE

9540 SERIES

TOP JAMB SINGLE DOOR (OFFSET PIVOT/BUTT HINGE, CENTER PIVOT, PUSH) MOUNTING

Consult factory for all balance door installations.

HOLLOW METAL FRAME

Suggested Installation.

MAXIMUM OPENING

Template allows 90 degree power opening and 90 degree manual opening.

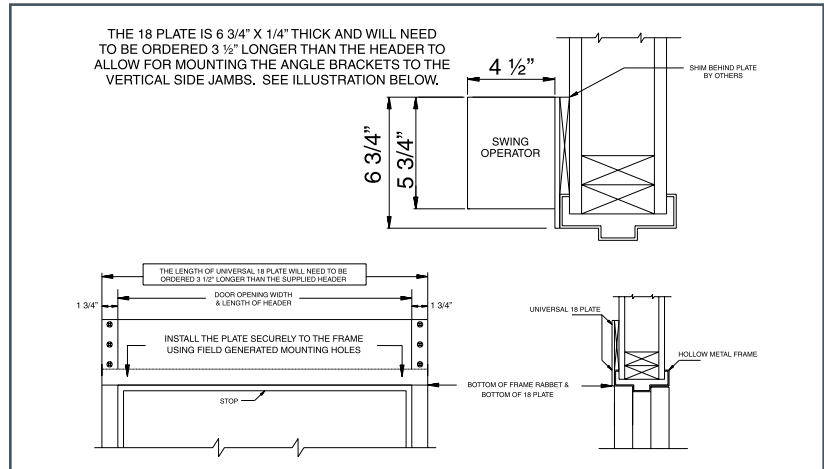
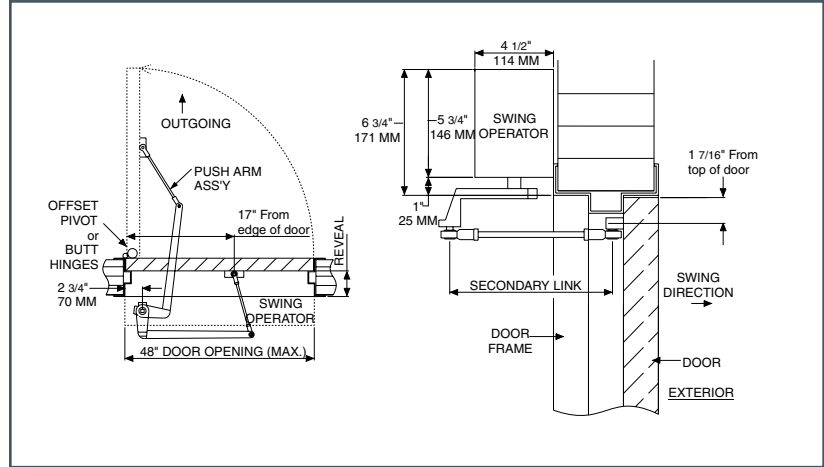

- **Butt Hinges** should not exceed 5" (127 mm) in width.
- **Reveal** for push installations should not exceed 10" (254 mm) for REGULAR ARM and 20" (508 mm) for LONG ARM.
- **Head Frame** minimum 1-3/4" (44 mm). Face frame 6-3/4" (171 mm) total operator clearance.
- **Top Rail** minimum 2-3/4" (70 mm).
- **Opening & Closing Time** are variable by adjustments to the electronic control box. Maximum hold open time adjustable up to approximately 32 seconds.
- **System Diagram** see "AUTOMATIC OPERATORS" section pages 53 for typical system wiring and page 56 for electrical data.

Contact LCN Product Support for installation assistance.

9540 SERIES

MOTOR GEARBOX

MOTOR GEARBOX – SENIOR SWING, 9540-3454

Driving mechanism for operator. Provides 15 lbs opening force. Handed.

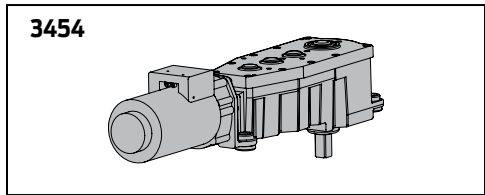

MOUNTING BRACKET

MOUNTING BRACKET – 2-3/4", 9540-275

Motor gearbox mounting bracket for 2-3/4" offset pivot or butt hinge installations. Front bracket.

REAR MOUNT BRACKET, 9540-3018

Motor gearbox mounting bracket. Rear bracket.

ANGLED BRACKET, 9540-334-1

Mounting bracket for surface applications. (Includes 2 mounting brackets).

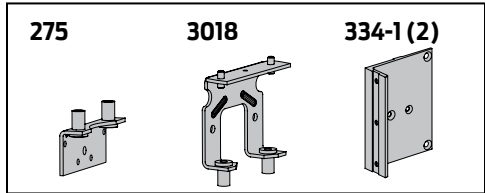

CONTROL BOXES

CONTROL BOX – SENIOR SWING, 9540-3462

Electronic controlling device for Senior Swing.

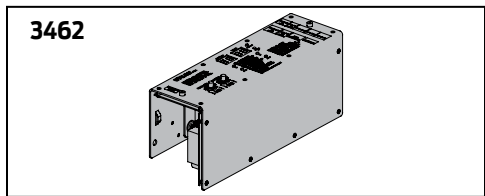

HEADERS

Header, 9540-3572HL

Standard, mounting header. Single door, single operator. Specify length 33" to 48" maximum.

Header, 9540-3572DD

Standard, mounting header. Double door, single operator. Specify length 49" to 98" maximum.

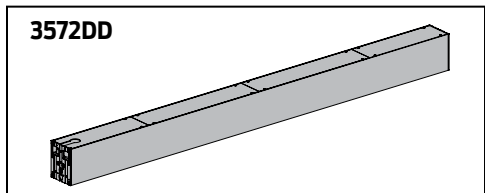
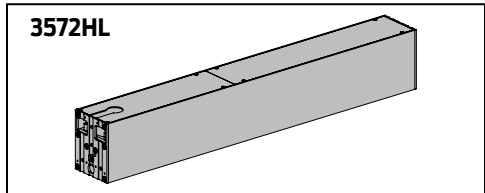

END CAPS

HEADER END CAPS, 9540-334

End cap with openings for wiring.

END DRESS PLATE, 9540-334-2

Metal finish end cap.

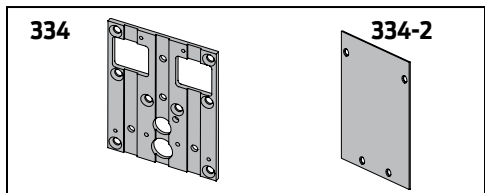

9540 SERIES

ARMS

REGULAR ARM ASSEMBLY, 9540-3077

Handed arm.

REGULAR LONG ARM ASSEMBLY, 9540-3077L

Handed arm.

MAIN ARM, 9540-77

Handed arm attaches to motor gearbox.

LINKAGE ASSEMBLY – 15", 9540-79

Threaded rod attaches to door. Extends from main arm.

LINKAGE ASSEMBLY – 32", 9540-79LR

Threaded long rod attaches to door. Extends from main arm.
Used for reveal 10" to 20".

INSTALLATION ACCESSORIES

SPINDLE PLATE – 2-3/4", 9540-11A

Hides bottom of motor gearbox. Completes header box. Cutout allows for motor gearbox shaft. For 2-3/4" offset pivot or butt hinge installations.

FILLER PLATE BLANK, 9540-12

Completes length of header box. (Specify length).

MOUNTING PLATE, 9540-18

Optional mounting plate for standard hollow metal door frames. Specify length 36-1/2" to 101-1/2" maximum, when angle brackets. Specify length 33" to 98" maximum when using end dress plates.

NOTE: The length of a universal 18 plate will need to be ordered 3-1/2" longer than the supplied header when using angle brackets.

3077
3077L

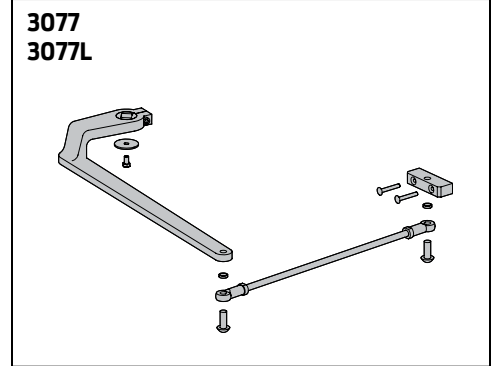

77

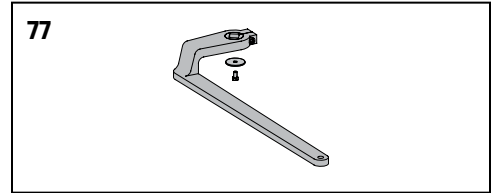

79
79LR

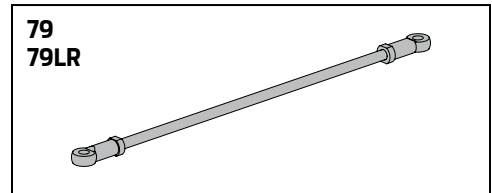

11A

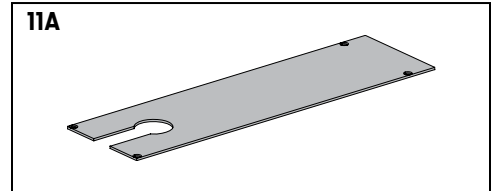

12

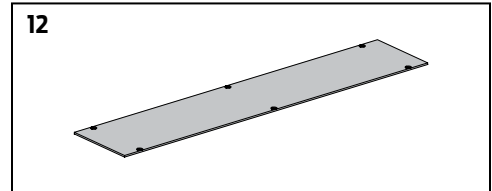

18

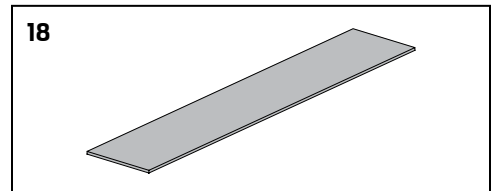

9540 SERIES

TABLE OF SIZES

DOOR WIDTH

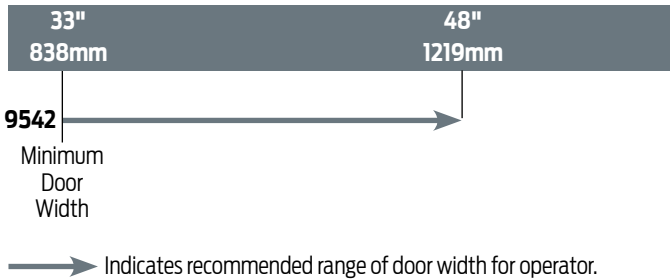

NOTE: For all Senior Swing Series.

Single Door - Width per leaf 33" minimum, 48" maximum.

HOW-TO-ORDER 9540 SERIES OPERATORS

1. SPECIFY HAND

RH

LH

2. SPECIFY HEADER/LENGTH

HL__ (Specify length 33" to 48")

DD__ (Specify length 49" to 98")

3. SPECIFY FINISH

Standard Anodized Finish _____
Aluminum or Dark Bronze.

Operator will be shipped with:

- STANDARD MOTOR GEARBOX,
 - STANDARD CONTROL BOX,
 - HEADER (at specified length, 36" standard),
 - REGULAR ARM (3077),
 - 2-3/4" PIVOT POINT,
 - WOOD and MACHINE SCREW PACK
- Unless options listed below are selected.*

OPERATOR OPTIONS

MOUNTING PLATE

Plate, ____ (Specify Length 33" to 101-1/2")

ARM

Long Arm (3077L)

ORDERING INFORMATION