

4410 HSA SERIES

FEATURES

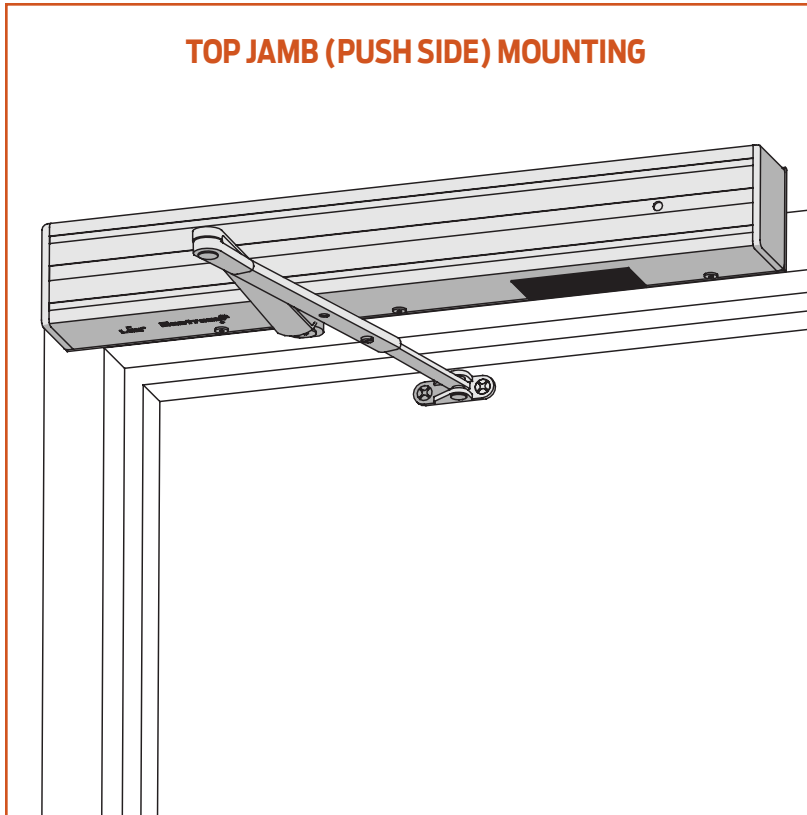

The 4410HSA SENTRONIC® is an electrically controlled closer/holder designed to provide easy passage for groups of pedestrians through high traffic doors. Pedestrians, moving through the doorway, trigger the built-in scanner. When the door is opened to 80° or more, the door is electrically held open to minimize wear and tear on applied door hardware. After the last pedestrian in a group passes through the doorway, the system timer releases the hold-open, closing the door under control of the heavy duty closer. Double lever arm closer is specifically designed for push side mounting. Choice of finishes and accessories meet virtually all high traffic installation requirements.

- Standard 4410HSA Series closer shipped with a 24V cylinder, standard cover, regular arm and wood & machine screw pack. See 4410HSA Series page 45 for options.
- HSA features a scanner activated hold-open function.
- Hold-open period is adjustable up to 30 seconds.
- Sized cylinders for interior doors to 4'6".
- Functions as full rack and pinion door closer when current is interrupted or continuous hold-open is not engaged.
- Handed for right or left swinging door.
- Concealed or surface wiring. 24V AC/DC input only. 120V AC input requires 4410HSA-3210 transformer or 8310-824.
- Built-in "On/Off" switch provides continuous hold-open function.
- Standard or optional custom powder coated finish.
- Optional plated finish on cover, arm and fasteners.

Tested and certified under ANSI Standard A156.4 and A156.15. Conforms to life safety code, NFPA 101.

MOUNTING					FINISH		COVER		CYLINDER			*ARM FUNCTION						
HINGE (PULL SIDE)	TOP JAMB (PUSH)	STOP FACE (PUSH)	CONCEALED (FRAME)	CONCEALED (DOOR)	POWDER COAT	PLATED	PLASTIC	METAL	HANDED	NON-SIZED	SIZED	SINGLE-POINT/HOLD-OPEN	MULTI-POINT/HOLD-OPEN	BYPASS 80/140	STANDARD (SINGLE)	REGULAR (DOUBLE)	SWING FREE	DOUBLE EGRESS
○	●	○	○	○	●	●	○	●	●	○	○	●	○	○	○	○	○	○

- AVAILABLE
- NOT AVAILABLE

* Maximum hold-open point with standard template. See individual closer series for degrees of opening and hold-open per installation.

4410 HSA SERIES

TOP JAMB (PUSH) SIDE MOUNTING

MAXIMUM OPENING

Templating allows 160°
 Infinite hold-open points from 80° up to 150°
 Optional long arm allows 180° hold-open points up to 170°.

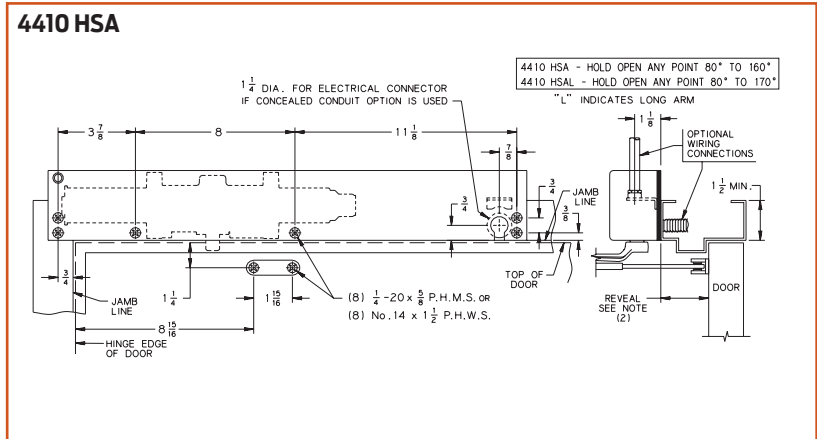

- **Butt Hinges** should not exceed 4-1/2" (114 mm) in width.
- **Top Rail** 1-3/4" (44 mm) minimum.
3-3/4" (95 mm) minimum with flush ceiling.
- **Head Frame** requires 1-1/2" (38mm) minimum.
2" (51 mm) minimum with flush ceiling.
- **Reveal** 3-7/8" (98 mm) maximum for regular or long arm. For reveals greater than 3-7/8" consult factory.
- **Wiring Diagram**

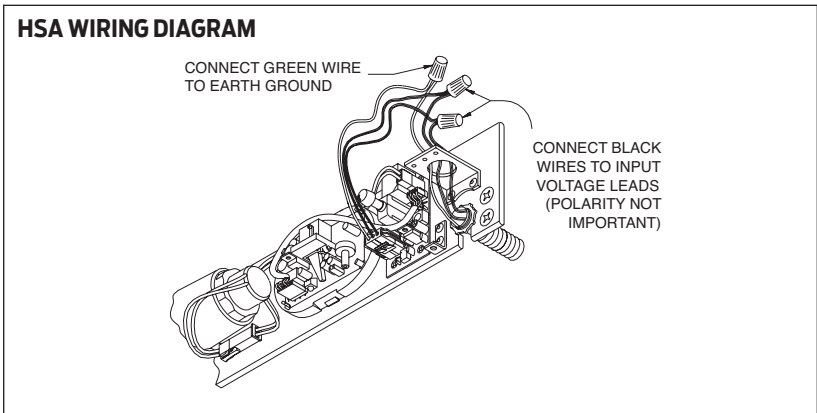

Options

- Optional long arm allows 180° with hold-open points up to 170°.
- Optional -18G plate accommodates flush ceiling conditions.
- 120 volt input requires 4410HSA-3210 transformer to change 120V AC to 24V AC.

Special Templates

Customized installation templates or products may be available to solve unusual applications. Contact LCN Product Support for assistance.

4410 HSA SERIES

CYLINDER

HSA CYLINDER, 4312HSA-3971

Standard, handed cast iron cylinder assembly. 24V AC/DC input only for holding solenoid.

HSA CYLINDER, 4312HSA-3071

Standard, handed cylinder and mounting plate assembly. Includes scanner module and system timer module. "On/Off" switch assembly provides continuous hold-open function. 24V AC/DC input only for holding solenoid and electronics modules.

COVERS

METAL COVER, 4410HSA-72MC

Handed, metal cover.

ARM

REGULAR ARM, 4410HSA-3077

Non-Handed Arm.
3-7/8" (98 mm) maximum reveal.

LONG ARM, 4410HSA-3077L

Optional arm for increased opening.
3-7/8" (98 mm) maximum reveal.

SWITCH

SWITCH, 4410HSA-3448

"On/Off" switch assembly provides continuous hold-open function.

SCANNER

SCANNER MODULE, 4410HSA-3428

INSTALLATION ACCESSORIES

MOUNTING PLATE, 4410HSA-18

Standard mounting plate.

MOUNTING PLATE, 4410HSA-18G

Optional mounting plate substituted on flush ceiling installations.

TRANSFORMER, 4410HSA-3210

Reduces line voltage from 120V to 24V AC. Mounted on plate for 4" (102 mm) x 4" x 2-1/8" (54 mm) junction box (by others).

3971

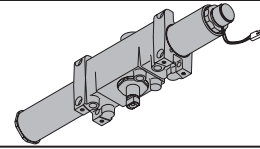

3071

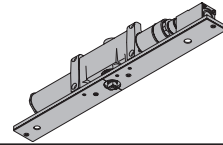

72MC

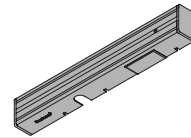

3077

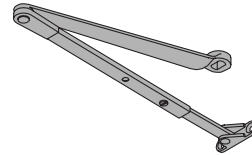

3077L

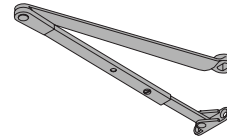

3448

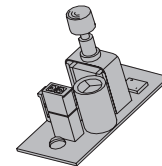

3428

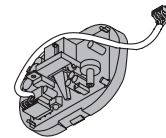

18

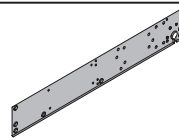

18G

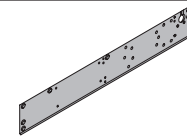

3210

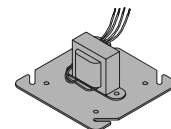

4410 HSA SERIES

TABLE OF SIZES

Closing power of 4410HSA Series closers may be increased 15%.

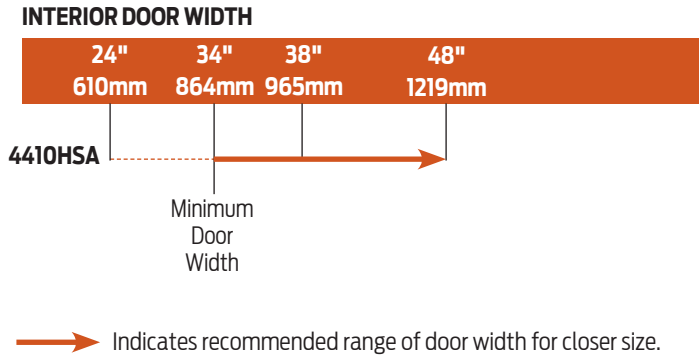

HOW-TO-ORDER 4410 HSA SERIES CLOSERS

1. SPECIFY HAND

- RH
- LH

2. VOLTAGE

- 24V AC/DC

3. SPECIFY FINISH

- Standard Powder Coat _____
Aluminum, Dark Bronze, Tan, Statuary,
Light Bronze, Black, Brass.

Closer will be shipped with:

- 24 AC/DC HSA CYLINDERS,
- METAL COVER,
- REGULAR ARM,
- WOOD & MACHINE SCREW PACK,
unless options listed below are selected.

CLOSER OPTIONS

ARM

- Long Arm (LONG)

FINISH

- Custom Powder Coat (RAL) _____
- Plated Finish, US _____

SCREW PACK

- TB*, Wood & Machine Screw (TBWMS)
- TORX Machine Screw (TORX)
- TB* & TORX Machine Screw (TBTRX)
- * Specify door thickness if other than 1-3/4".

INSTALLATION ACCESSORIES

- Plate, 4410HSA-18
- Plate, 4410HSA-18G
(substituted for standard mounting plate)
- Transformer, 4410HSA-3210

SPECIAL TEMPLATE

- ST- _____ (if required)