

# 4020T SERIES

## FEATURES

The 4020T is LCN's best performing heavy duty track closer designed specifically for interior doors in institutional and other high traffic applications.

- Cast Iron
- Forged Steel Arm
- Double Heat Treated Steel Pinion
- All Weather Fluid
- UL & cUL Listed
- Peel-n-Stick Templates for Fast and Accurate Installations

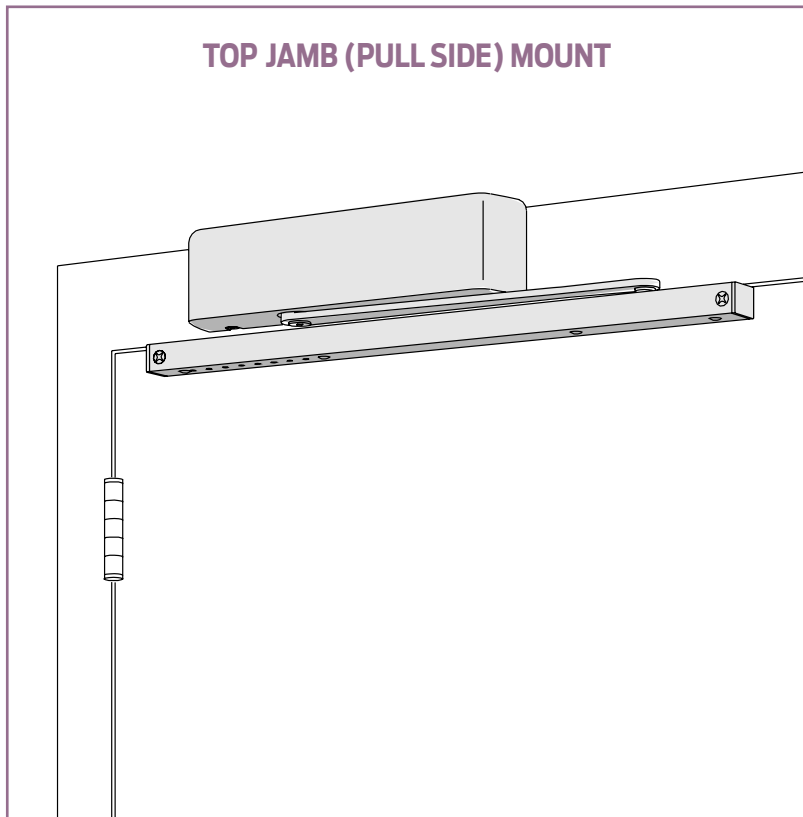

- Standard 4020T Series closer is shipped with standard arm, standard track, track roller, standard plastic cover, and self reaming and tapping screws. See 4020T Series pages 19 & 20 for options.
- Sized cylinders for interior doors to 4'0".
- Closer mounts top jamb (pull side), specify right or left swinging door.
- Standard or optional custom powder coat finish.
- Optional plated finish on metal cover, arm and fasteners.
- Optional SRI primer for installations in corrosive conditions is available with powder coat only.
- The 4020T Series is UL and cUL listed with a standard track for self-closing doors.
- Tested and certified under ANSI Standard A156.4, grade one.

MOUNTING					FINISH		COVER		CYLINDER			**ARM FUNCTION									
HINGE (PULL SIDE)	TOP JAMB (PULL)	TOP JAMB (PUSH)	PARALLEL ARM	STOP FACE	POWDER COAT	PLATED	PLASTIC	METAL	NON-HANDED	NON-SIZED	ACCESSIBILITY	DELAYED ACTION	AVB***	REGULAR (DOUBLE)	STANDARD (SINGLE)	HOLD-OPEN	FUSIBLE LINK	EDA/HEDA	CUSH/HCUSH	SCUSH/SHCUSH	DOUBLE EGRESS
<input type="radio"/>	<input checked="" type="radio"/>	<input type="radio"/>	<input type="radio"/>	<input type="radio"/>	<input checked="" type="radio"/>	<input checked="" type="radio"/>	<input checked="" type="radio"/>	<input checked="" type="radio"/>	<input type="radio"/>	<input type="radio"/>	<input type="radio"/>	<input checked="" type="radio"/>	<input type="radio"/>	<input type="radio"/>	<input checked="" type="radio"/>	<input type="radio"/>	<input type="radio"/>	<input type="radio"/>	<input type="radio"/>	<input type="radio"/>	<input type="radio"/>

● AVAILABLE  
○ NOT AVAILABLE

Closer available with less than 5.0 lbs. opening force on 36" door.  
\*\* Maximum opening/hold-open point with standard template.  
\*\*\* Advanced Variable Backcheck.

# 4020T SERIES

## TOP JAMB (PULL SIDE) MOUNTING

### MAXIMUM OPENING

Templating allows 180° with standard track arm, limited to 100° with optional bumper installed.

Consult factory if door will be held open at 180°.

Hold-open points at 80°, 85°, 90°, 95°, or 100° with hold-open tracks.

Please note that many track style door closers are capable of allowing 180° of door swing. Be aware that the majority of track style closers are at their weakest closing force in the 180° – 130° range. Consult factory for applications where door must swing 180°.

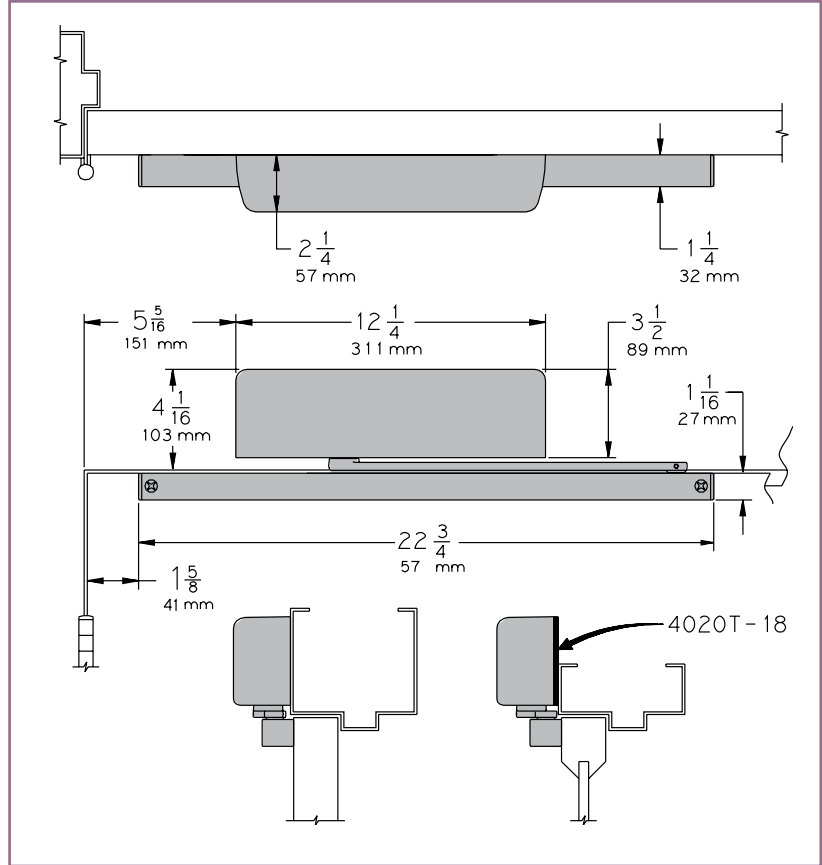

- **Butt Hinges** should not exceed 5" (127 mm) in width.
- **Auxiliary Stop** is recommended at hold-open point or where a door cannot swing 180°. Optional track bumper assembly assists backcheck in cushioning the opening swing of the door. It is not intended to replace an auxiliary stop.
- **Reveal** should not exceed 1/8" (3 mm).
- **Head Frame** less than 3-7/8" (98 mm), requires PLATE, 4020T-18. Plate requires 1-3/4" (44 mm) minimum.
- **Clearance** of 1-1/2" (38 mm) behind door required for 90° or 180° installation.

### Options

- Standard track with bumper, hold-open track, hold-open track with bumper.
- Metal cover.

### Special Templates

Customized installation templates or products may be available to solve unusual applications. Contact LCN Product Support for assistance.

# 4020T SERIES

## CYLINDERS

### CYLINDER, 4020T-3071

Standard, handed cast iron cylinder assembly.  
For various applications see "Table of Sizes" on 4020T Series page 21.

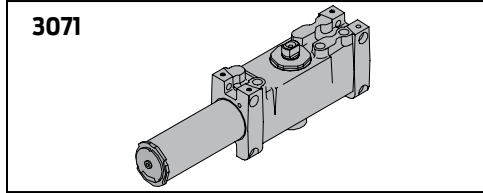

## COVERS

### COVER, 4020T-72

Standard, handed plastic cover.

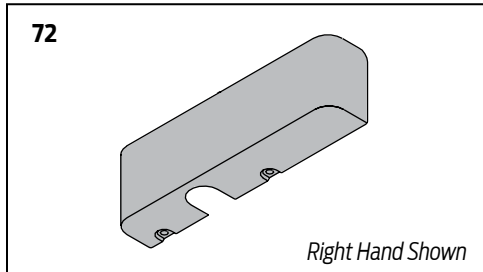

### METAL COVER, 4020T-72MC

Optional, handed cover. Required for plated finishes and custom powder coat finishes.

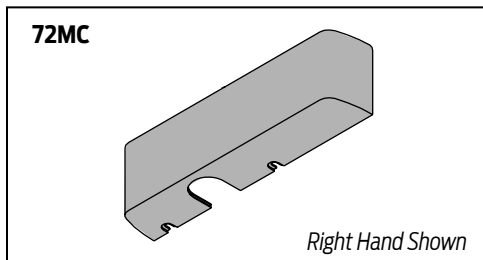

## ARMS

### STANDARD ARM, 4020T-3077T

Handed arm. Roller not included with arm.

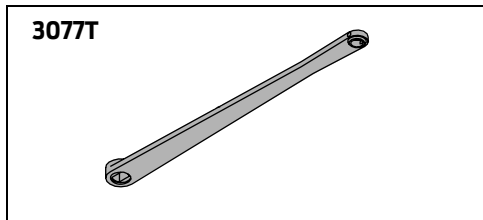

## TRACKS

### STANDARD TRACK, 4020T-3038

Standard, non hold-open, non-handed track.  
Will accept hold-open clip and/or bumper assembly.

### STANDARD TRACK with BUMPER, 4020T-3038B

Optional non hold-open, non-handed track with bumper assembly installed. Will accept hold-open clip.

### HOLD-OPEN TRACK, 4020T-3038H

Optional, non-handed track with hold-open clip installed.  
Will accept bumper assembly.

### HOLD-OPEN TRACK with BUMPER, 4020T-3038HB

Optional, non-handed track with hold-open clip and bumper assembly installed.

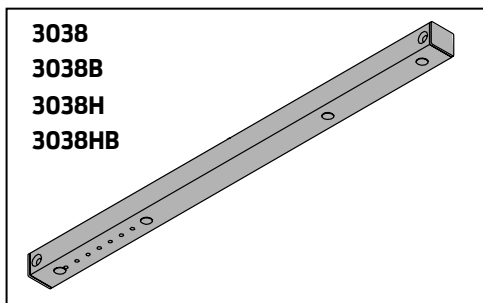

# 4020T SERIES

## INSTALLATION ACCESSORIES

### PLATE, 4020T-18

Required where head frame is less than 3-7/8" (98 mm).  
Plate requires minimum 1-3/4" (44 mm) frame face.

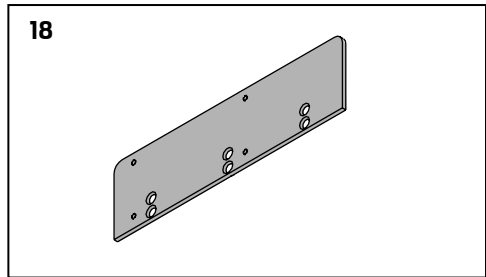

### TRACK BUMPER, 4020T-169

Mounts in track to assist backcheck, not replace auxiliary stop.  
Limits maximum opening. Consists of bumper, bumper post, and mounting screw.

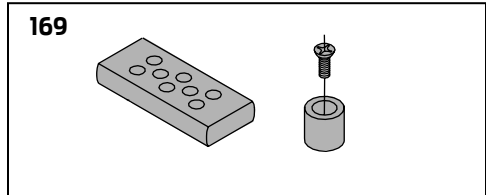

### HOLD-OPEN CLIP, 4020T-3054

Mounts in track to provide hold-open function.  
Hold-open point controlled by clip location.  
Consists of clip and mounting screws.

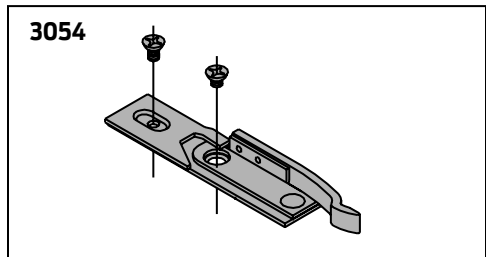

### TRACK ROLLER, 4020T-3034

Quiet, low friction roller assembly.  
Shoulder dimension "X" = 1/16" (2mm).

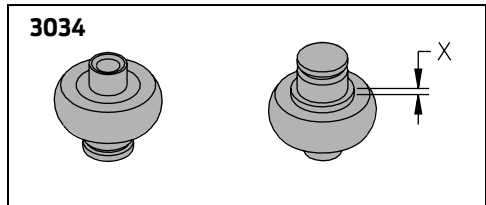

# 4020T SERIES

## TABLE OF SIZES

Select closer based on width of door.

4020T Series cylinders available in size 1, 3 or 4.

Closing power of all 4020T Series closers may be increased 15%.

Specify next higher size closer where strong drafts exist.

### INTERIOR DOOR WIDTH

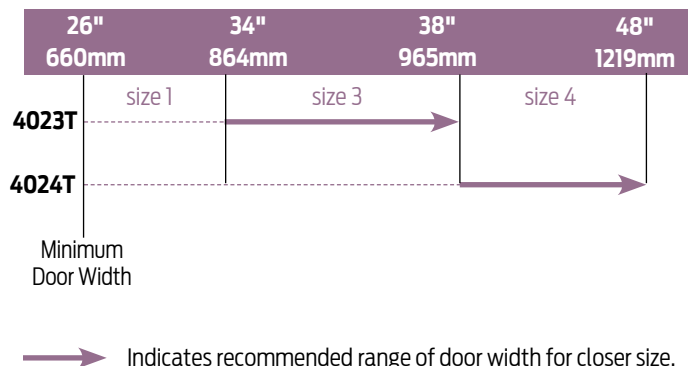

## HOW-TO-ORDER 4020T SERIES CLOSERS

### 1. SELECT CYLINDER SIZE

- 4021T (ADA)
- 4023T
- 4024T

### 2. SPECIFY HAND

- RH
- LH

### 3. SPECIFY FINISH

- Standard Powder Coat \_\_\_\_\_  
Aluminum, Dark Bronze, Statuary,  
Light Bronze, Black, Brass.

#### Closer will be shipped with:

- STANDARD COVER,
- STANDARD ARM,
- TRACK ROLLER,
- STANDARD TRACK,
- SELF-REAMING and TAPPING SCREWS,  
*unless options listed below are selected.*

## CLOSER OPTIONS

### COVER

- Metal (MC)

#### FINISH

- Custom Powder Coat (RAL) \_\_\_\_\_  
(handed metal cover required)
- Plated Finish, US \_\_\_\_\_  
(handed metal cover required)
- SRI primer (use with powder coat finishes only)

### TRACK

- Standard with Bumper (BUMPER)
- Hold-Open (HO)
- Hold-Open with Bumper (HBUMPER)

### SCREW PACK

- TB\* & SRT Screw (TBSRT)
  - Wood & Machine Screw (WMS)
  - TB\*, Wood & Machine Screw (TBWMS)
  - TORX Machine Screw (TORX)
  - TB\* & TORX Machine Screw (TBTRX)
- \* Specify door thickness if other than 1-3/4".

### INSTALLATION ACCESSORY

- Plate, 4020T-18

### SPECIAL TEMPLATE

- ST- \_\_\_\_\_