

**FALCON®**

Medium  
duty

Commercial pushpads



# Table of contents

4	1490 Concealed vertical rod touchbar
5	1590 Rim touchbar
6	1690 Concealed vertical rod touchbar
7	1790 Rim touchbar
8	19-R Series
9	F-19-R Series
10	19-V Series
11	F-19-V Series
12	Accessories
13	Strikes
14	Power supply
15	Trim designs
16	Trim chart
17-18	Type and function
19	Door application
20-21	How to order



# The Falcon difference

## Safety, security and uncompromising value

At Falcon, we know that every product you sell not only has to meet local building codes, but also your expectations for performance and quality. We take your expectations seriously, and that's why we build our exits to deliver durability, convenience and unmatched value. After all, we've built our reputation on the same standards that you have – providing quality products at a reasonable price delivered on time. It's the way we do business and it's what makes Falcon exits a powerful choice no matter what your project.



# 1490 Concealed vertical rod touchbar device

The 1490 offers a clean appearance with pushpad styling and a variety of practical features. The 1490 is built with rugged steel operating mechanisms, and durable aluminum push bars and end caps.



Length	Minimum door size (non-EL)	Minimum door size (EL)
36"	25 3/4"	34 3/4"
42"	25 3/4"	34 3/4"
48"	36 3/4"	43 3/4"

Consult factory for special sizes.



## Specifications

Hand:	Specify RHR or LHR-supplied RHR if not specified.
Functions:	See trim selection chart on this page.
Finishes:	US28, DC13, DC 35, US3, US9, US10, US4, US10B, US14, US15.
Strikes:	PB48 top.
Latches:	RL - Rod bottom latch (standard), Hex bottom latch (standard for EL), PL - Pullman bottom latch (optional), ES - electric strike top latch (optional). Device needs to be less bottom rod (LBR).
Dogging feature:	Quarter turn hex dogging standard. No threaded parts to wear out.
Cylinder:	Rim, night latch (NL) or hold back (HB) feature available. Simplified cartridge mounting for most standard rim cylinders. Furnished in DC35 if not specified.
Sizes:	36", 42", 48".
Doors:	1 3/4" thick metal doors-specify if other than 1 3/4".
Projections:	2 3/4" maximum, 2" when dogged. Pushbar height is 3".
Stile:	1 3/4" minimum.
Electric functions:	EL - electric latch retraction, include "S". Requires PS914-2RS minimum power supply. S- latch bolt monitor switch (SPDT). Conversion kits available. Devices are handed.
Fasteners:	All mounting screws are concealed. Uses all machine screws for device and latch.
End caps:	Durable zinc die cast, powder coated.
Vertical rods:	1' standard, extension rods available up to 7' 10".
ANSI:	Certified ANSI A156.3 2001 Grade 1 standards.
Shim kits:	1/2" riser is available.
High security:	1490 High Security devices are used for hurricane rated door openings. Consult door manufacturer's listing.

Model	Trim package	Type	Function
1490	No outside trim	6	01
1491	Pull only (9970)	6	02
1492	NL cylinder	6	03
1493	HB cylinder	6	04
1494	Pull (9970) w/ NL cylinder	6	02/03
1495	Pull (9970) w/ HB cylinder	6	02/04
1498	Dummy	6	

# 1590 Rim touchbar device

The 1590 offers the clean looks and easy pushpad design of the 1490 with the installation and maintenance ease of a rim exit device.



Length	Minimum door size (non-EL)	Minimum door size (EL)
36"	25"	35"
42"	25"	35"
48"	36"	43"

Consult factory for special sizes.

Model	Trim package	Type	Function
1590	No outside trim	6	01
1591	Pull only (9970)	6	02
1592	NL cylinder	6	03
1593	HB cylinder	6	04
1594	Pull (9970) w/ NL cylinder	6	02/03
1595	Pull (9970) w/ HB cylinder	6	02/04

## Specifications

Hand:	Non handed, "push" labels for each hand supplied standard.
Functions:	See trim selection chart on this page.
Finishes:	US28, DC13, DC35, US3, US9, US10, US4, US10B, US14, US15.
Strikes:	TD35 strike supplied standard. STK45 optional.
Latchbolt:	1 1/4" high x 3/4" projection, hardened steel.
Dogging feature:	Quarter turn hex key dogging.
Cylinder:	Night latch (NL) or hold back (HB) feature available, simplified cartridge mounting for most standard rim cylinders, furnished in DC35 if not specified.
Sizes:	36", 42", 48".
Doors:	1 3/4" thick metal or wood, specify if other than 1 3/4".
Projections:	2 3/4" maximum, 2" when dogged. Pushbar height is 3".
Stile:	2" minimum.
Electric functions:	EL - electric latch retraction, include "S". Requires PS914-2RS minimum power supply. S - latch bolt monitor switch (SPDT). Conversion kits available. Devices are handed.
Fasteners:	All mounting screws are concealed.
Endcaps:	Durable zinc die cast, powder coated.
ANSI:	Certified ANSI A156.3-2001 Grade 1 standards.
Shim kits:	1/2" riser is available.
Retractors:	Used for cylinder assembly, special retractors available for use with mullions.
Mullions:	Removable mullions are available for pairs of doors, see page 12.

# 1690 Concealed vertical rod touchbar device

The design of the 1690 is ideal for demanding, moderate-traffic applications. The vertical rods and latch mechanisms are concealed in the vertical door stile, ensuring trouble-free operation. Cast metal cover plates and end caps hold up to rigorous use. A quick, single-point dogging feature in the housing deactivates the device, permitting unrestricted traffic flow. The 1690 may also be used to retrofit a 1990 Series crossbar device.



Length	Minimum door size (non-EL)	Minimum door size (EL)
30"	24"	28 1/2"
36"	30"	34 1/2"
42"	36"	40 1/2"
48"	42"	46 1/2"

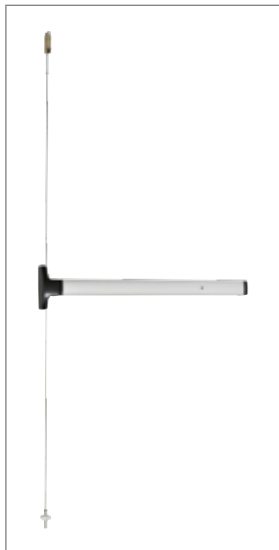

### Positioning retractor as shown for NL or HB functions.

Install retractor as shown below for both RHR and LHR doors; this makes all keys function in the same direction.

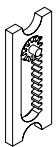

Hold back (HB)

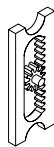

Night latch (NL)

## Specifications

Hand:	Field reversible, non-handed.
Functions:	See trim selection chart on this page.
Finishes:	US28, DC13, DC 35, US3, US10, US26, US26D. Centercase and end cap are powder-coated black only.
Strikes:	PB48 top.
Latches:	Standard top - SU latch. Standard bottom - hex bottom bolt. Optional top - ES - electric strike top latch, device must be less bottom rod (LBR). Optional bottom - RL - rod bottom latch. - PL - pullman bottom latch.
Dogging feature:	Hex key dogging standard, except EL where must use hold back feature on outside cylinder.
Cylinder:	Rim, night latch (NL) or hold back (HB) feature available. Field selectable.
Sizes:	30", 36", 42", and 48".
Doors:	1 3/4" thick metal doors, specify if other.
Projections:	3 3/8" in neutral position, 2 3/8" in dogged position. Pushbar height is 2 1/2".
Stile:	1 3/4" minimum.
Electric functions:	EL - electric latch retraction, ED - electric dogging (both EL and ED require PS914-2RS minimum power supply). RX - request to exit switch, monitors pushpad SPTD switch.
Fasteners:	All machine screw mounting. Device mounting fasteners are concealed, latch fasteners are exposed to egress side.
End caps:	Black powder-coated metal end caps.
Vertical rods:	7' standard, extension rods available up to 10'. Rod extension kits available.
ANSI:	Certified ANSI A156.3 grade 1 standards.
High security:	1690 High security devices are used for hurricane rated door openings. Consult door manufacturer's listing.

Model	Trim package	Type	Function
1690	No outside trim	6	01
1691	Pull only (9970)	6	02
1692	Cylinder only	6	03/04
1693	Pull and cylinder	6	02/03/04

# 1790 Rim touchbar device

The 1790 rim device is typically used in applications where maintenance is a concern because the rim device has fewer parts and pieces than current exit devices. The result is less maintenance and adjustment. The streamlined design has no openings for chains, reducing the risk for code infringements and offering increased building security by eliminating the possibility of tampering and forced entry through the use of coat hangers and other tools. The 1790 may also be used to retrofit a 2090 series crossbar device.



Length	Minimum door size (non-EL)	Minimum door size (EL)
30"	24"	28 1/2"
36"	30"	34 1/2"
42"	36"	40 1/2"
48"	42"	46 1/2"

- Lock/unlock capability
- ADA accessible
- Lever designs
  - Dane
  - Sutro
  - Quantum

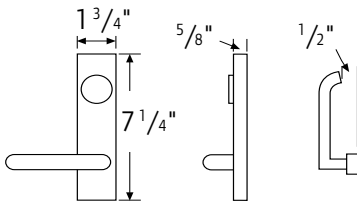

Lever projection: Quantum = 3"  
 Sutro = 2 7/8"  
 Dane = 2 7/8"

Key locks or unlocks trim. Lever retracts latchbolt when trim is unlocked. Dane, Quantum and Sutro levers return to within 1/2" of door.

## Specifications

Hand:	Non handed.
Functions:	See trim selection chart on this page.
Finishes:	US28, DC13, DC35, US3, US10, US26, US26D. Centercase and end cap are powder-coated black only.
Strikes:	TD35 strike supplied standard, see page 11 for other rim strikes available.
Latchbolt:	1" thickness, 3/4" throw.
Dogging feature:	Hex key dogging standard, except EL where must use hold back feature on outside cylinder.
Cylinder:	Rim, night latch (NL) or hold back (HB) available (field selectable).
Sizes:	30", 36", 42", and 48".
Doors:	1 3/4" thick metal or wood, specify if wood door.
Projections:	3 3/8" in neutral position, 2 3/8" in dogged position. Pushbar height is 2 1/2".
Stile:	1 3/4" minimum.
Electric functions:	EL - electric latch retraction, ED - electric dogging (both EL and ED require PS914-2RS minimum power supply). RX - request to exit switch, monitors pushpad SPTD switch.
Fasteners:	All machine screw mounting. Device mounting fasteners are concealed, latch fasteners are exposed to egress side.
End caps:	Black powder-coated metal end caps.
ANSI:	Carry UL label and approved for life safety. Certified ANSI A156.3 grade 1 standards.
Mullions:	Removable mullions are available for pairs of doors, see page 12.

Model	Trim package	Type	Function
1790	No outside trim	4	01
1791	Pull only (9970)	4	02
1792	Cylinder only	4	03/04* or 08/09*
1794	Pull (9970) and cylinder	4	02/03/04

\*Requires use of 179L

# 19-R Series non-handed rim device

## Panic exit hardware

The Falcon 19-R Series rim device that delivers superior panic hardware with modern touchbar styling.

This non-handed device covers a 161 cutout and may be used on 1 3/4" narrow stile aluminum doors.

The "EO" (exit only) device is ready to accept any trim function shown on page 17.

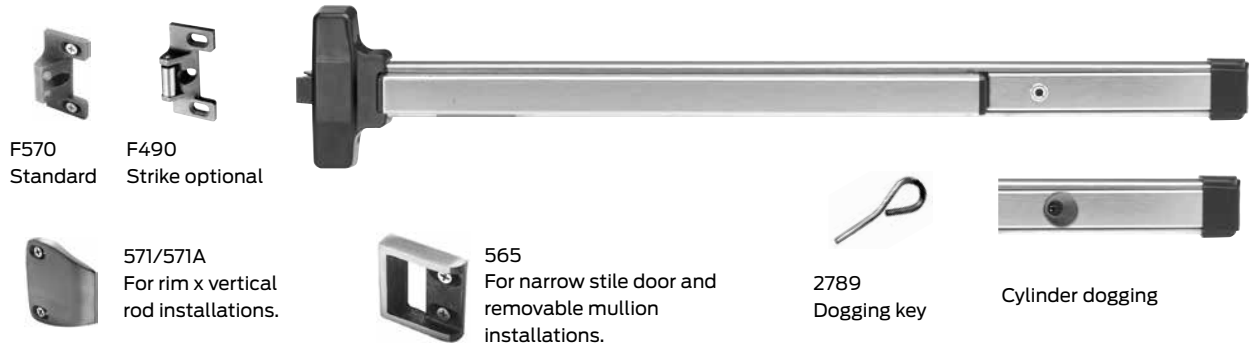

Device & trim	ANSI type	ANSI function
19-R-EO	1 or 4	01
19-R-DT	1 or 4	02
19-R-NL	1 or 4	03
19-R-K (or L or KIL)	1 or 4	08
19-R-K-NL (or L-NL or kil-nl)	1 or 4	09
19-R-TP-BE	1 or 4	
19-R-K-BE	1 or 4	
19-R-K-DT	1 or 4	
19-R-L-BE	1 or 4	
19-R-L-DT	1 or 4	
19-R-KIL-BE	1 or 4	
19-R-KIL-DT	1 or 4	

Note: For blank escutcheon specify BE.

### Specifications

Hand:	Non-handed.
Functions:	See trim selection chart on this page.
Finishes:	SP28, SP313, US32D. Centercase and end cap are powder-coated black only.
Strikes:	Standard - F570. Optional - F490, 565, 571, 571A.
Latch:	Stainless steel, 3/4" throw dead locking.
Dogging feature:	Hex key dogging standard. Cylinder dogging or less dogging optional.
Sizes:	3' for doors from 2'5" up to 3'. 4' for doors from 3' up to 4'.
Doors:	1 3/4" thick metal or wood doors, specify if other.
Projections:	2 1/2" in neutral position, 1 7/8" in dogged position. Pushbar height is 1 3/4".
Stile:	1 3/4" minimum.
Fasteners:	All machine screw mounting. Device mounting fasteners are concealed, latch fasteners are exposed to egress side.
End caps:	Black plastic end caps.
ANSI:	Certified ANSI A156.3 grade 1 standards.



# F-19-R Series non-handed rim device

## 🔥 Fire exit hardware

The F-19 Rim fire exit device is an excellent addition to the touchbar. This device is non-handed and is listed by UL for B label fire door installations on 4'0" x 7'2" single doors and/or 8'0" x 7'2" double doors with an F-4023 removable mullion or KRF-4023. The "EO" (exit only) device is ready to accept any trim function shown on page 17.



F570  
Standard



F490  
Strike optional



Device & trim	ANSI type	ANSI function
F-19-R-EO	1 or 4	01
F-19-R-NL	1 or 4	03
F-19-R-K (or L or KIL)	1 or 4	08
F-19-R-K-NL (or L-NL or KIL-NL)	1 or 4	09

Note: For blank escutcheon specify BE

### Specifications

UL:	"B" label (1 1/2" hr.); 4'0" x 7'2".
Functions:	All functions built into "EO" device. All 19 series trim works with rim or vertical devices. See trim selection chart on pages 15 and 16.
Finishes:	Power-coated aluminum-SP28; power-coated duranodic-SP313; stainless steel US-32D.
Strikes:	Stainless steel, F570 or F490.
Latchbolt:	Stainless steel, 3/4" throw.
Deadlocking latchbolt:	Standard.
Sizes:	3' for doors from 2'5" up to 3'. 4' for doors from 3' up to 4'.
Doors:	1 3/4" thick wood or metal. Specify thickness if other than 1 3/4". (SNB must be specific on wood or composite doors.)
Projections:	2 1/2" in neutral position, 1 7/8" in depressed position. Pushbar height is 1 3/4".
Sex bolts:	When used with wood, composite or non-reinforced hollow metal, sex bolts must be specific, 3-#4122 (1/4"-20)SNB standard. An additional 2-#2729 (10-24) SNB must be specified.
ANSI:	Certified ANSI A156.3-2001 grade 1 standards.
Shim kit:	For glass lite applications; 1/4" thick specify SK 19-R-1/4".
161 Cutout:	Device covers 161 cutout with KIL and Centron trims. Other trim requires cover plate.



# 19-V Series non-handed vertical rod device

## Panic exit hardware

Manufactured to the same standards as the 19 Rim, the 19-V exit device complies with most exit door requirements, and is fully reversible and surface applied. This device is regularly furnished with deadlocking top latch with latch retention and square bolt at bottom. The "EO" (exit only) device is ready to accept any trim function shown on page 17.

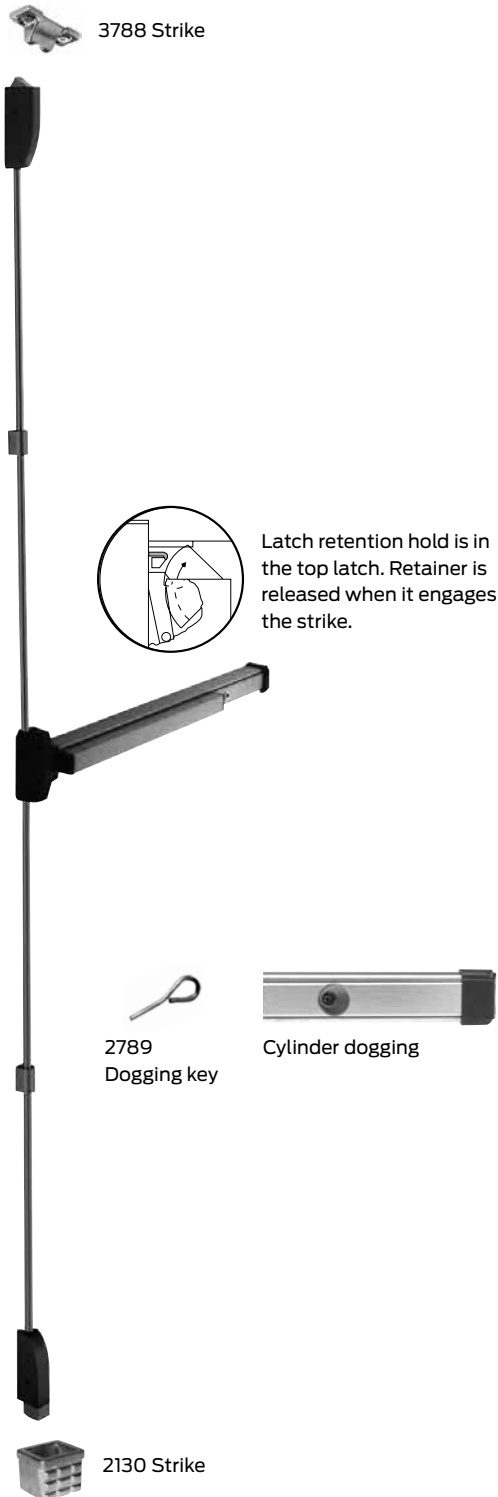

Device & trim	ANSI type	ANSI function
19-V-EO	2 or 5	01
19-V-DT	2 or 5	02
19-V-NL	2 or 5	03
19-V-K (or L)	2 or 5	08
19-V-K-NL (or KIL)	2 or 5	09

Note: For blank escutcheon specify BE.

### Specifications

Hand:	Field reversible.
Functions:	All functions built into "EO" device. All 19 Series trim works with rim or vertical devices. See Trim Selection Chart on pages 15 and 16.
Finishes:	Powder-coated aluminum-SP28; powder-coated duranodic-SP313; stainless steel US-32D.
Strikes:	3788 strike is surface applied standard, 2130 strike is mortised into floor.
Angle bracket:	Use 4215 angle bracket in flush transom or rabbeted installations. Allows use of standard 3788 strike.
Latchbolt:	Top stainless steel $\frac{3}{4}$ " throw. Bottom square bolt $\frac{1}{2}$ " throw.
Deadlocking latchbolt:	Standard.
Dogging feature:	Half turn hex dogging standard. No threaded parts to wear out.
Cylinder dogging:	Specify "CD" prefix. Use $1\frac{1}{8}$ " long mortise cylinder with standard "A" cam.
Stock sizes:	3' for doors from 2'5" up to 3'. 4' for doors from 3' up to 4'.
Doors:	$1\frac{3}{4}$ " thick, wood or metal. Specify thickness if other than $1\frac{3}{4}$ ".
Narrow stile doors:	To $1\frac{3}{4}$ " N.S. aluminum. With control trim- $2\frac{1}{4}$ " min. stile.
Projection:	$2\frac{1}{2}$ " max., $1\frac{7}{8}$ " dogged.
Fasteners:	All mounting screws are concealed. Furnished with sheet metal screws. Machine screws available, specify AMS.
Sex bolts:	3-#4122 ( $\frac{1}{4}$ "-20) SNB standard. Hollow core wood, light gauge hollow metal, etc. require additional sex bolts. 19-V: 6-#2729 #10-24 SNB; 19-V-LBR: 3-#2729 #10-24 SNB
ANSI:	Certified ANSI A156.3 2001 grade 1 standards.
19-V:	Latch retention and 3788 strike top, deadbolt and 2130 flush strike bottom.
19-V-LBR:	3788 strike top.
Vertical rods:	Furnished to length based on $40\frac{5}{16}$ " horizontal CL from finished floor and a 7'0" door standard. Variations from these standards must be specified when ordering.
Shim kit:	For glass lites applications; $\frac{1}{4}$ " thick specify SK-19-V- $\frac{1}{4}$ ".
161 cutout:	Device covers 161 cutout with KIK/KIL and Centron trims. Other trim requires cover plate.

# F-19-V Series non-handed vertical rod device

## Fire exit hardware

Manufactured to the same standards as the F-19 Rim, the F-19-V  Fire exit device complies with most exit door requirements, and is fully reversible and surface applied. This device is regularly furnished with deadlocking top latch retention and square bolt at bottom. (This device is listed by UL for “B” label fire door installations.) The “EO” (exit only) device is ready to accept any trim function shown on page 17.

 3788 Strike

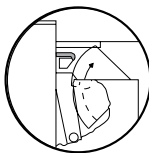
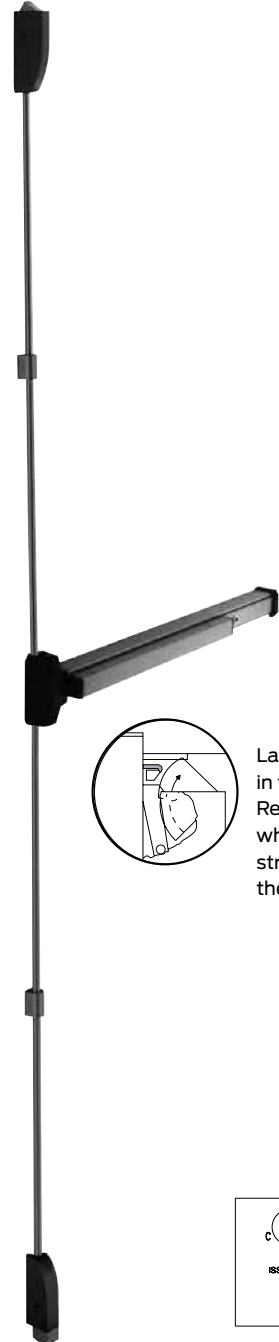

Latch retention hold is in the top latch. Retainer is released when it engages the strike. The door is in the closed position.



 2130 Strike

Device & trim	ANSI type	ANSI function
F-19-V-EO	2 or 5	01
F-19-V-DT	2 or 5	02
F-19-V-NL	2 or 5	03
F-19-V-K (or L or KIL)	2 or 5	08
F-19-V-K-NL (or L-NL or KIL-NL)	2 or 5	09

Note: For blank escutcheon specify BE.

### Specifications

Hand:	Field reversible.
Functions:	All functions built into “EO” device. All 19 Series trim works with rim or vertical devices. See Trim Selection Chart on pages 15 and 16.
Finishes:	Powder-coated aluminum—SP28; powder-coated duranodic—SP313; stainless steel US-32D.
Strikes:	3788 strike is surface applied. 2130 strike is mortised into floor.
Latchbolt:	Top stainless steel 3/4" throw. Bottom square bolt 1/2" throw.
Deadlocking latchbolt:	Standard.
Stock sizes:	3' for doors from 2'5" up to 3'. 4' for doors from 3' up to 4'.
Doors:	1 3/4" thick, wood or metal. Specify if other than 1 3/4" thick.
Projection:	2 1/2" maximum.
Fasteners:	All mounting screws are concealed. All machine screws standard.
Sex bolts:	3— #4122 (1/4"-20) SNB standard. Composite or non-reinforced wood, hollow metal require additional sex bolts. F-19-V: 6— #2729 #10-24 SNB; F-19-V-LBR: 3— #2729 #10-24 SNB.
ANSI:	Certified ANSI A156.3-2001 grade 1 standards.
F-19-V:	Latch retention and 3788 strike top deadbolt and 2130 flush strike bottom.
F-19-V-LBR:	Latch retention and 3788 strike top.
Vertical rods:	Furnished to length based on a 40 3/16" horizontal CL from finished floor and a 7'0" door standard. Variations from these standards must be specified when ordering.
Shim kit:	For glass lites applications; 1/4" thick specify SK-19-V-1/4".
161 cutout:	Device covers 161 cutout with KIK/KIL and Centron trims. Other trim requires cover plate.

# Trim designs

## Control trim

SP28, SP313 and US-32D.

### K-control L-control



**911K**  
BE  
NL

**L-Control-Avalon 912L**  
BE  
L-DT  
NL

**L-Control-Dane 912L**  
BE  
L-DT  
NL

**L-Control-Sutro 912L**  
BE  
L-DT  
NL

**L-Control-Quantum 912L**  
BE  
L-DT  
NL

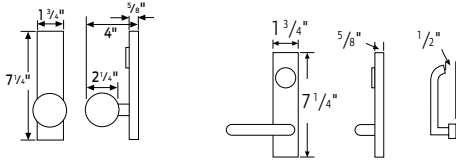

Key locks or unlocks trim. Knob retracts trim. Knob retracts latchbolt when trim is unlocked.

Lever Projection: Quantum = 3"  
Sutro = 2 7/8"  
Dane = 2 7/8"  
Avalon = 3"

Key locks or unlocks trim. Lever retracts latchbolt when trim is unlocked. Dane, Quantum and Sutro levers return to within 1/2" of door.

### DT-control NL-control Pull



**918 DT**  
Pull when dogged.

**918NL**  
Key retracts latchbolt.

**9970**  
Can be used with all devices.

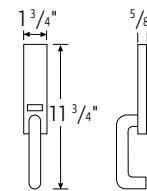

9 1/4" center to center  
2 7/8" projection  
1 3/4" clearance

### Cover plates



**4167**  
3 1/4" x 15" x .050  
Used with TP control & DT control  
Covers 161 & 86 cutouts

**4168**  
3 1/4" x 7 1/2" x .050  
Used with EO device to cover No. 86 cutout for mortise lock

**4170**  
3 1/4" x 7 1/2" x .050  
Used with K control, DT/K control, L control, or DT/L control  
Covers 161 & 86 cutouts

### Key-in-lever



**914KIL**

**914-KIL-IC**

### Centron trim

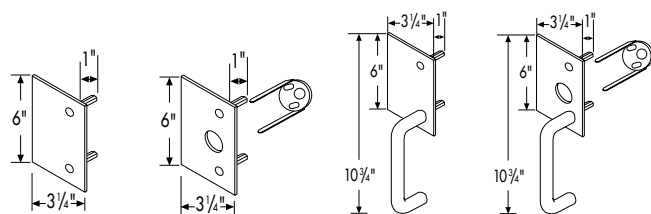

**930 EO**

**930 C**

**930 DT**

**930 NL**

**Pull only 917 DT**  
CTC - 5 1/2" round - 3/4" dia.  
Pull when dogged.

### Trident trim

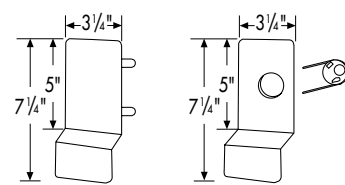

**920 DT**

**920 NL**

# Trim chart

## Control

Device	DT	NL	T-BE	K	K-BE	K-DT
19-R/19-V	918	918	910	911	911	911
Cylinder type	—	rim	—	1 1/8" Mortise	—	—

Device	Avalon*			Dane*			Sutro*			Quantum*		
	L	L-BE	L-DT	L	L-BE	L-DT	L	L-BE	L-DT	L	L-BE	L-DT
19-R/19-V	912	912	912	912	912	912	912	912	912	912	912	912
Cylinder type	1 1/8" Mortise	—	—	1 1/8" Mortise	—	—	1 1/8" Mortise	—	—	1 1/8" Mortise	—	—

## KIL

Device	KIL*	KIL-LS/LK'	KIL-NL*	KIL-IC*
19-R/19-V	914	914	914	914
	Falcon "C" keyway A23160	—	Falcon "C" keyway A23160	Small format

## Trident trim

Device	Trident trim		Centron		
	NL	DT	C	DT	NL
19-R/19-V	920	920	930	930	930
Cylinder type	Rim	—	Rim	—	Rim

\* Specify hand.

Note: For "NL" night latch function on K and L add "NL" after trim number.  
All locking trim except KIL furnished less cylinder.

# Type and functions

These pages list all functions available for the 19 Series devices.

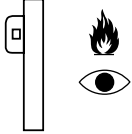
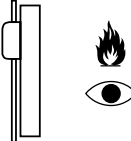
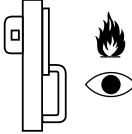
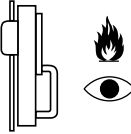
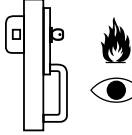
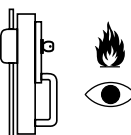
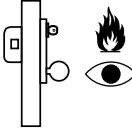
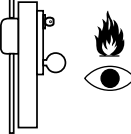
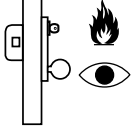
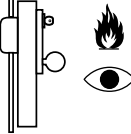
	<b>Rim devices ANSI type 1 and 4.</b>	<b>Vertical rod devices ANSI type 2 and 5.</b>
<b>Functions (ANSI)</b>	<b>(F)-19-R</b>	<b>(F)-19-V</b>
<p><b>EO or N (01)</b> Exit only, no trim.</p>	 <b>19-R-EO</b>	 <b>19-V-EO</b>
<p><b>DT (02)</b> Entrance by trim when actuating bar is dogged down.*</p>	 <b>19-R-DT</b>	 <b>19-V-DT</b>
<p><b>NL (03)</b> Entrance by trim when latchbolt is retracted by key. Key removable only when locked.</p>	 <b>19-R-NL</b>	 <b>19-V-NL</b>
<p><b>K or L or KIL(08)</b> Entrance by knob or lever. Key locks or unlocks knob.</p>	 <b>19-R-K or L or KIK or KIL</b>	 <b>19-V-K or L or KIK or KIL</b>
<p><b>K(NL) or L(NL) (09) or KIL (NL) or KIL (NL)</b> Entrance by knob or lever only when released by key. Key removable only when locked.</p>	 <b>19-R-K (NL) or L(NL) or KIK(NL) or KIL(NL)</b>	 <b>19-V-K (NL) or L(NL) or KIK(NL) or KIL(NL)</b>



Fire exit hardware

Use "F" prefix for fire exit hardware.



Security monitor



Electric function

\*Latch, device, and authorize degress monitors. (See electrified hardware catalog.)

\*Fire exit devices cannot be dogged down. Some codes permit electric dogging with fail secure circuitry.

# Type and functions

## Double doors

Device & trim	Length	Top strike	Bottom strike	Min. stile	Door opening width
(F) 19-V	3'0"	3788	2130	3 1/2"	2' 5 1/4" to 3'0"
(F) 19-V	4'0"	3788	2130	3 1/2"	3'0" to 4'0"

Note: For (F-) 19-V-LBR use "V" information less bottom strike. F-19-V-LBR requires use of auxiliary fire latch.

## Single doors with 5/8" stop

Device & trim	Length	Strike	Min. stile	Door opening width
19-R	3'0"	F570 565	3 1/2" 1 3/4"*	2'5 1/4" to 3'0" 2' 4 3/4" to 2' 9 1/4"
F-19-R	3'0"	F570	3 1/2"	2'5 1/4" to 3'0"
19-R	4'0"	F570 565	3 1/4" 1 3/4"*	3'0" to 4'0" 3'0" to 3'9 3/4"
F-19-R	4'0"	F570	3 1/4"	3'0" to 4'0"

\*For EO, O with pull and NL functions only. 2- 1/4" minimum stile required for control trim.

## Dimensions:

- Recommended height from finished floor - 40 5/16" at CL.
- Touchbar projections: neutral - 2 1/2" depressed - 1 7/8"
- Extension rods or longer top rods available upon request.
- Specify door height.
- Dummy touchbar available. Specify 190 DT 3' or 4'.
- Overall length: 3' 30 1/2"- 4' 42 5/8"
- Changes for minimum door size for charts on left:
- For cylinder dogging, add 2 1/4" to minimum door size.
- For exit alarm, add 4 1/2" to minimum door size.
- To fit on smaller door consult factory

## Double doors with Mullion

Device & trim	Length	Strike	Min. stile	Door opening width	Fire	Panic
19-R	3'0"	F570	3 1/2" 3 3/4"	2'5 1/4" to 3'0"	-	29231 4023/ KR4-23
		565	3 1/8" 3 3/8"	2'4 3/4" to 2'9 1/4"	-	29231 4023/KR4023
F-19-R	3'0"	F-570	3 3/4"	2'5 1/4" to 3'0"	(F)4023 KR(F)4023	-
19-R	4'0"	F570	3 1/2" 3 3/4"	3'0" to 4'0"	-	29231 4023/ KR4-23
		565	3 1/8" 3 3/8"	3'0" to 3'9 3/4"	-	29231 4023/KR4023
F-19-R	4'0"	F-570	3 3/4"	3'0" to 4'0"	(F)4023 KR(F)4023	-

<sup>1</sup>To cover 161 cutout on double door installation, specify 2923 mullion with 565 strike.



# Door applications

## Door thickness

All devices and components supplied for 1 3/4" doors standard. Specify door thickness if other than 1 3/4".

Number	BHMA/ANSI function
01	Exit only, no trim.
02	Entrance by trim when actuating bar is locked down.
03	Entrance by trim when latchbolt is retracted by key; key removable only when locked.
04	Entrance by trim when latchbolt is retracted by key or set in a retracted position by key.
08	Entrance by knob or lever; key locks or unlocks knob or lever.
09	Entrance by knob or lever only when released by keys; key removable only when locked.

U.S. standard	BHMA	Description
US28	628	Anodized aluminum – clear
DC13	710	Anodized aluminium – dark bronze
DC35	711	Anodized aluminum – black
P28	689	Painted aluminum – silver
P13	695	Painted aluminum – dark bronze
P35	622	Painted aluminum – black
US3	666	Bright brass
US4	667	Satin brass
US9	705	Bright bronze
US10	668	Satin bronze
US10B	703	Oxidized satin bronze
US14	669	Bright nickel
US15	670	Satin nickel
US26	672	Bright chrome
US26D	702	Satin chrome

## Door application chart

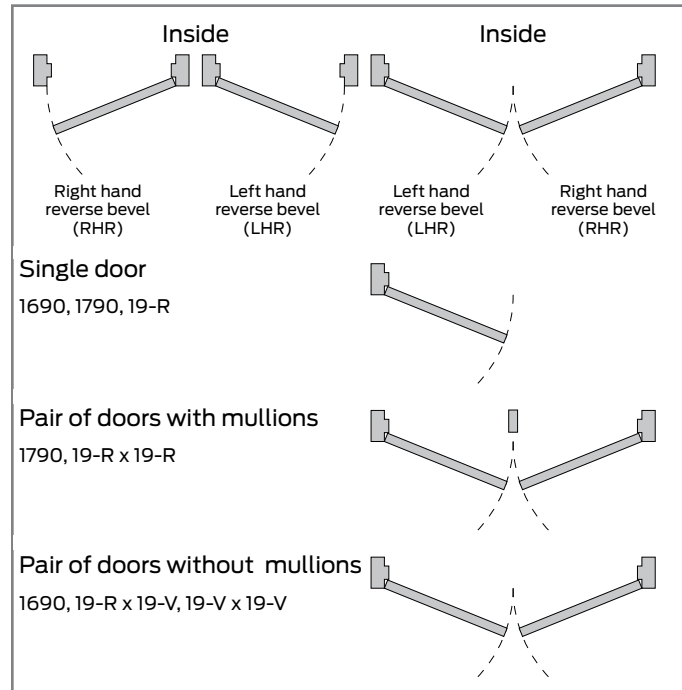

Device	Label	Door opening	Application
<b>Hollow metal door</b>			
F-19-R	1 1/2 hr. "B"	4' x 7'2" 8' x 7'2"	Single, pair, same egress w/ F-4023 mullion and KR-F-4023
F-19-V	1 1/2 hr. "B"	8' x 10'	Pair, double egress, same egress
F-19-V-LBR	1 1/2 hr. "B"	8' x 8'	Pair, double egress, same egress
<b>Wood door</b>			
F-19-V-LBR	20 min.	8' x 8'	Wood or comp., pair, double egress, same egress
F-19-R	1 1/2 hr. "B"	4' x 7'2" 8' x 7'2"	Single, pair, same egress w/ F-4023 mullion and KR-F-4023

## 19 Device dimensions:

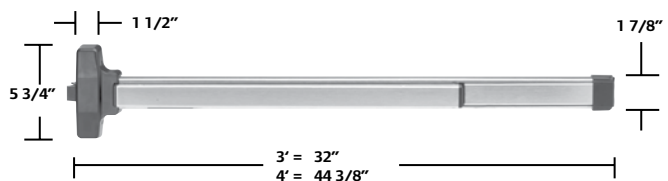



# Strikes /accessories

## Strikes

### 1690 Concealed vertical rod device



**PB48**  
Top strike for 1690 device. Packed with three 0.050" thick shims. 1 1/16" x 1 1/16" x 7/16" (H x W x D)

### 1790 Rim device



**STK45**  
Strike for inactive leaf, pair of doors with 1790 device. 3 1/4" x 1 5/16" x 1/4" (H x W x D)



**TD35**  
Strike for single doors, 1790 device. Includes 1/8" shim. 3" x 2" x 1/2" (H x W x D)

### (F) 19-R Rim devices



**F570**  
Standard strike. 2 5/8" x 1 1/4" x 19/16" (H x W x D)



**F490**  
Optional strike. 2 5/8" x 1 1/4" x 7/8" (H x W x D)



**565**  
Adjustable surface mounted for use with blade or applied stops. Mounts flush for 1/2" stop height.



**571/571A**  
Used on inactive leaf for device on active leaf of pair of doors without removable mullion. 571 keeps 2 5/16" backset. 571A is trimmer and projects less into opening.

### (F) 19-V Surface vertical rod devices



**3788**  
Top strike for 19-V.



**2130**  
19-V bottom strike for grouting into concrete or masonry floors.



**4155**  
19-V optional bottom strike.



**2126A**  
19-V optional bottom strike.

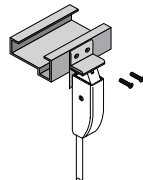

**4215**  
Angle bracket for 19-V devices flush transom applications. Does not require elimination of latch retention feature.



**Extension rods**  
Extension rods are available in 12", 24" and 36" lengths in all finishes. Both ends tapped and all-thread included as connector.

## Popular EL application

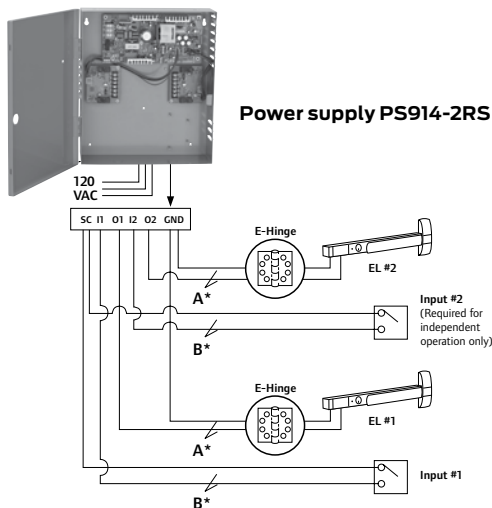

### EL Device wire selection size

A*	Run length	EL device w/EPT or door loop
	0-100 ft.	14 gauge
	100-200 ft.	12 gauge

A*	Run length	EL device w/electric hinge/pivot
	0-75 ft.	14 gauge
	76-150 ft.	12 gauge

B*	Wire selection	Switch wire size
	1200 ft. max.	18 gauge

# Power supply



The PS900 series is a consolidated line of power supplies and accessories that offer enhanced flexibility and functionality specific to the changing needs of the access control market. The PS900 series can be used in a variety of applications to convert high voltage AC power into the low voltage DC outputs required by most access control devices. The PS900 series protects devices downstream by providing Class 2\*, filtered and regulated power. The full line is UL294 certified.

Note: PS906 can provide Class 2 rated outputs when used with 900-8P distribution board.

## Features:

- Constant output rating at both 12 VDC and 24 VDC provides superior performance ; includes field selectable jumper
- Polarized connectors for option boards eliminate need for racks and side connectors
- Flat mounting of option boards provides easier access to terminal blocks for connection of electrified devices
- High voltage protective cover
- Battery back-up board auto-selects voltage
- Fire alarm relay can be configured to provide either switched or un-switched outputs from a power supply
- PS914 designed with high in rush current for powering electrified panic devices
- Universal 120-240 VAC input
- Low voltage DC, regulated and filtered
- Electronic power limiting foldback circuit for AC current overload protection
- Fused primary input
- AC status monitor- isolated SPDT contacts
- AC input and DC output LED status indicators
- Cover mounted AC input indication
- Hinged cover with lock down screws

## Certifications:

- UL 294 certified—the standard for access control
  - Class 2 rated\*
- \* Except PS906, output rating exceeds Class 2 power limits

Once power is converted to low voltage DC, the PS900 Series offers a variety of distribution options, including basic fuse

protection, simple relay, and advanced logic providing complex sequencing and timing functions.

\* PS906 can provide Class 2 rated outputs when used with 900-8P distribution board.

	PS902	PS904	PS906	PS914
<b>Number of connectors on power supply for the following:</b>				
2 amps				
4 amps				
6 amps				
4 amps				
Distribution boards	1	2	3	2
Battery back-up board	1	1	1	1

Note: One fire alarm board can be connected directly to the PS902. If a fire alarm board is desired for the PS904, PS906 or PS914 it can be connected to a distribution board.

## Applications:

The PS900 series of power supplies works with many electrified devices including Falcon exit devices, electromagnetic locks, hardwired locks, electrified mechanical locks, electrified strikes and many other products.

## Accessories:

The PS900 series features seven option boards for use in a variety of applications. All PS900 series power supplies option boards are UL 294 certified.

### Option boards:

**900-4R:** 4 relay controlled output board to power multiple devices

**900-4RL:** 4 relay distribution board with logic is field configurable for time delay function, auto operator, security interlock

**900-8F:** Provides 8 individually fuse-protected outputs, giving the flexibility to power multiple devices and provide another layer of protection

**900-FA:** Emergency interface relay integrates with fire alarm and is used to cut power in case of emergency

**900-BB:** Battery backup

**900-2RS:** 2 relay EL panic device control board (PS914 only)

**900-BBK:** Battery backup kit includes two 7A/hr batteries and provides up to four hours of backup power when cycled every 5 minutes at full load.

### Wire selection size / type

Run length	EL device w/ EPT or door loop
0-100 ft	14 gauge standard wire
101-200 ft	12 gauge standard wire
Run length	EL device w/ electric hinge / pivot
0-75 ft	14 gauge standard wire
76-150 ft	12 gauge standard wire
Wire selection	Switch wire size
1200 ft max.	16 gauge

# Accessories



F-4023 Shown

## Removable mullion

- Removable mullions are easily removed and reinstalled for full width access
- Increased security and tighter closure
- Minimizes door warp age and sag
- Regulates the traffic flow in-and-out
- Rim devices are used on both leaves, attaining a perfect symmetrical opening
- Mullion assembly consists of a mullion, top and bottom fittings and mounting package
- Mullion can be cut on the job for doors under stock lengths

## 2923, (F)4023, (F)KR4023 Mullion

These steel mullions can be used with the 19-R and F-19-R devices. Soffit adapters are available for the 2923 and 4023 mullions. The F4023 and F-KR4023 fire-rated mullions also include four stabilizer blocks as required for labeled installations. Strikes are not included with mullion and should be specified with the 19-R or F-19-R device, see page 11 for strike information. KR mullions require 1 1/8" mortise cylinder with standard "A" cam. The mullion fittings are made from ductile iron. The (F)4023 and (F)KR4023 are 2" wide and 3" deep. The 2923 is 1 1/2" wide and 2 1/2" deep. Furnished in prime coat.

## Mullions



RM 170



Mullion brackets



525 Mullion stabilizer for RM170

## RM 170 Removable mullion

RM 170 for use with 1790 series. Comes complete with adjustable mortised strikes and security clips. Compatible with doors 7' to 10' and for use with stiles as narrow as 1 3/4". Made of aluminum, available in anodized aluminum or bronze finishes. Mullion is 3 1/2" deep, 1" wide on door side, and 1 5/8" at the widest point.

## Mullion strikes



### STK170

Adjustable mortise strikes (pair).

- 2 7/8" tall
- 1 3/4" wide
- 1" thick

## Sex bolts

Sex bolts are available for 1 3/4" door thickness. Screws to fit are available in 3/4" and 2" lengths to cover a wide range of door thicknesses.

2729 (#10-24 thread)

4122 (1/4"-20 thread)

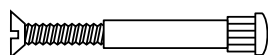

## Filler plates

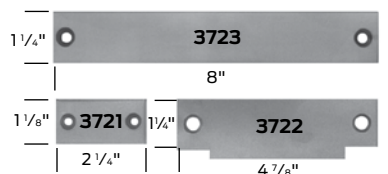

## 3721/3722/3723

Steel filler plates

- 3721 Cylindrical lock frontfiller
- 3722 ASA strike filler - set no. SC for 161 cutout
- 3723 Mortise lock front filler
- 3722 ASA strike filler - set no. SM for 86 cutout

# How to order

## 1490/1590

		EL	1492	EO	36"	US28	CYL	RL*	RHR*
<b>HH</b>	High security device *								
<b>EL</b>	Electric latch retraction								
<b>S</b>	Signal switch - monitors latch bolt								
<b>1490</b>	See model numbers on page 4								
<b>1590</b>	See model numbers on page 5								
<b>EO</b>	Exit only								
<b>DT</b>	Dummy trim								
<b>NLOP</b>	Night latch cylinder assembly - optional pull								
<b>HBOP</b>	Hold back cylinder assembly - optional pull								
<b>NLP</b>	Night latch cylinder assembly with 9970 pull								
<b>HBP</b>	Hold back cylinder assembly with 9970 pull								
<b>36"</b>	36" (standard)								
<b>42"</b>	42" (optional)								
<b>48"</b>	48" (optional)								
<b>US28</b>	<b>DC35</b> <b>US9</b> <b>US4</b> <b>US14</b>								
<b>DC13</b>	<b>US3</b> <b>US10</b> <b>US10B</b> <b>US15</b>								
<b>RISER</b>	Riser (1/2")								
<b>CYL</b>	Rim cylinder								
<b>7 PIN CYL</b>	Cylinder assembly for 7-pin cylinder. Cylinder not included.								
<b>RL</b>	Standard bottom latch								
<b>HEX</b>	Standard EL bottom latch								
<b>PL</b>	Pullman bottomlatch								
<b>ES</b>	Top latch for use with electric strike								
<b>LBR</b>	Less bottom rod								
<b>RHR</b>	RHR								
<b>LHR</b>	LHR								

\*Applies to 1490 only

## 1690/1790

		EL	1690	EO	36"	US28	RL*
<b>HH</b>	High security device*						
<b>RX</b>	Request to exit switch						
<b>EL</b>	Electric latch retraction						
<b>ED</b>	Electric dogging						
<b>1690</b>	See model numbers on page 6						
<b>1790</b>	See model numbers on page 7						
<b>EO</b>	Exit only						
<b>DT</b>	Dummy trim						
<b>NL-HBOP</b>	Cylinder assembly - optional pull						
<b>NL-HBP</b>	Cylinder assembly with 9970						
<b>30"</b>	30" (optional)						
<b>36"</b>	36" (standard)						
<b>42"</b>	42" (optional)						
<b>48"</b>	48" (optional)						
<b>US28</b>	<b>DC35</b> <b>US10</b> <b>US26D</b>						
<b>DC13</b>	<b>US3</b> <b>US26</b>						
<b>1690 Only</b>							
<b>HEX</b>	Standard bottom latch						
<b>RL</b>	Rod bottom latch						
<b>PL</b>	Pullman lottomlatch						
<b>ES</b>	Top latch for use with electric strike						
<b>LESS RODS</b>	Less rods (retrofit of 1990 device)						
<b>LBR</b>	Less bottom rods						

\*Applies to 1690 Only

# 19 Series

		F	19	V	L-DANE	US32D	3'	L	HR	LBR	SNB	WD
<b>Prefixes</b>												
<b>CD</b>	Cylinder dogging											
<b>KOR</b>	Key bypass switch											
<b>Rating</b>												
<b>F</b>	Fire exit hardware											
<b>Blank</b>	Panic exit hardware											
<b>Device Series</b>												
<b>19</b>	Touch bar device, narrow stile											
<b>Device Type</b>												
<b>R</b>	Rim											
<b>V</b>	Surface vertical rod											
<b>Trim Function</b> (see Trim pages for all functions)												
<b>EO</b>	Exit only											
<b>DT</b>	Dummy trim											
<b>NL</b>	Night latch											
<b>C</b>	Cylinder trim less pull											
		<b>K</b>										
		<b>L</b>										
		<b>TL</b>										
		<b>KIL</b>										
<b>Finish</b>												
<b>US32D</b>												
<b>SP28</b>												
<b>SP313</b>												
<b>Door Width</b>												
<b>3'</b>	Standard default											
<b>4'</b>												
<b>-</b>	Specify exact door width											
<b>Handing</b>												
<b>RHR</b>	Right hand reverse											
<b>LHR</b>	Left hand reverse											
<b>Less bottom rod</b>												
<b>LBR</b>	Less bottom rod											
<b>LBR-AFL</b>	LBR w/auxiliary fire latch											
<b>Other device options</b>												
<b>RBB</b>	Round bottom bolt											
<b>SSTB</b>	Stainless steel touch bar											
<b>VRP</b>	Black pad on touch bar											
<b>TAC</b>	Tactile warning											
<b>Accessories</b>												
<b>CYL</b>	Cylinder											
<b>SNB</b>	Sex bolts											
<b>SK</b>	Shim kit											
<b>AMS</b>	All machine screws											
<b>Other miscellaneous door information</b>												
<b>HMD</b>	Hollow metal door											
<b>HMF</b>	Hollow metal frame											
<b>WD</b>	Wood door											
<b>WDF</b>	Wood frame											
<b>ALD</b>	Aluminum door											
<b>ALF</b>	Aluminum frame											
<b>SCDC</b>	Steel channel door construction											
-	Specify other door or frame											
-	Material information											
-	Door height											
-	Door thickness											
-	Door undercut											
-	Door label (20 min, 45 min, 90 min 1-1/2 hr)											
-	Stile width											
-	Frame stop height											
<b>SGL</b>	Single door											
<b>PR</b>	Pair of doors swinging same direction											





## About Allegion

Allegion (NYSE: ALLE) creates peace of mind by pioneering safety and security. As a \$2 billion provider of security solutions for homes and businesses, Allegion employs more than 8,000 people and sells products in more than 120 countries across the world. Allegion comprises 27 global brands, including strategic brands CISA®, Interflex®, LCN®, Schlage® and Von Duprin®.

For more, visit [www.allegion.com](http://www.allegion.com)

*aptiQ* ■ LCN ■ **SCHLAGE** ■ STEELCRAFT ■ VON DUPRIN