

9827/9927 Surface mounted vertical rod device



9827/9927 Surface mounted vertical rod device for all types of single or double doors, UL listed for panic exit hardware. Devices are ANSI A156.3 – 2001 Grade 1. Covers stock hollow metal doors with 86 or 161 cutouts. The 9827 device has a smooth mechanism case and the 9927 device has a grooved case. The surface vertical rod device is non-handed except when the following device options are used: SD (special dogging), or SS (signal switch). See opposite page for available outside trim and functions. Vertical rod and latch guards are available to protect the bottom rod of the exit device from damage by impacts of carts or gurneys passing through doors.

Finishes – US3, US3A, US4, US4A, US10, US26, US26D, US26D-AM Antimicrobial, US28, 313, 315 & 643E. US15 and US32D available with 98 Series only.

Specifications

Device functions	Device ships EO/DT/NL. Field selectable. For TP, K or L remove NL drive screw from device.	
Device lengths	2' 2" (610 mm)	Door size (shipped less UL label)
	3' 2'4" to 3' (711mm to 914 mm)	Door size
	4' 2'10" to 4' (864 mm to 1219 mm)	Door size
Device centerline from finished floor	39 ⁵ / ₈ " (1006 mm)	
Center case dimensions	8" x 2 ³ / ₄ " x 2 ³ / ₈ " (203mm x 70mm x 60mm)	
Mechanism case dimensions	2 ¹ / ₄ " x 2 ¹ / ₄ " (57mm x 57mm)	
Projection	Pushbar neutral – 3 ¹³ / ₁₆ " (97 mm) Pushbar depressed – 3 ¹ / ₁₆ " (78 mm)	
Latch bolt	Deadlocking anti-friction top & bottom bolt, ⁵ / ₈ " (16mm) throw	
Door undercut	1/4" (7mm) recommended	
Top & bottom Latch case	4 1/2" x 2 1/8" x 1 1/2" (114mm x 54mm x 38mm)	
Vertical rods	1/2" square tubing, standard rods accommodate 7' (2134mm) doors. Top rod length: 34 ¹⁵ / ₁₆ " (887mm); Bottom rod length: 31 1/2" (794mm) Extension rods available in 1' (205mm) or 3' (914mm) for doors over 7'. One piece top rod is available for 8' (2438mm) and 10' (3048mm) doors.	
Fasteners & sex bolts (SNB)	Includes screw pack for 1 ³ / ₄ " (44mm) to 2 ¹ / ₄ " (57mm) thick metal or wood doors, and 325 SNB for top and bottom latch. Optional 425 SNB available.	
Electric options	LX	Latchbolt monitor switch
	RX	Pushpad monitor switch
	RX2	Double pushpad monitor switch
	EL	Electric latch retraction
	QEL	Quiet electric latch retraction
	SS	Signal switch
	CX	Chexit delayed exit
	ALK	Alarm exit kit
	PN	Pneumatic latch retraction
	LBR	Less bottom rod
	WP-RX	Waterproof request to exit
	CON	Allegion Connect
Mechanical options	GBK	Glass bead kit
	PL	Pullman latch
	WS	Tornado and hurricane tested
	SNB	Sex bolts
	SEC	Security screws
Dogging feature	Hex key dogging standard	
Dogging option	CD	Cylinder dogging
	SD	Special center case dogging
	LD	Less dogging
	DI	Dogging indicator
	CI	Cylinder dogging indicator
Strikes	Top - 299 – Dull black, Bottom – 248L4 & 304L – Unfinished	



Hex key dogging comes standard on 9827/9927

WS
Windstorm

- Severe weather certified/tested
- FEMA and ICC compliant
- Tornado & hurricane tested

RX
Pushpad monitor switch

- Signals use of an opening
- SPDT switch to monitor pushpad

QEL
Quiet electric latch retraction

- Bolt retraction via switch
- Converts exit door to push-pull operation

CON
Allegion Connectors

- Common connectors to connect various door hardware all the way to the power supply

EL
Electric latch retraction

- Enables remote unlatching
- Alternative to manual dogging

ALK
Alarm exit kit

- Unauthorized opening triggers 85-decibel horn
- Set in armed or disarmed mode by key

E (E996L)
Electrified breakaway lever

- Electrified remote locking/unlocking
- Standard in fail safe condition

CX
Chexit delayed exit

- Meets NFPA 101 requirements
- Self-contained controls, locking, alarm

PN
Pneumatic latch retraction





- For areas where electrical devices banned
- Special linkage for mechanical or pneumatic dogging





SS
Signal switch

- Signals unauthorized use of an opening
- Switch makes latch bolt tamper-resistant

9827/9927 Surface mounted vertical rod device

Standard trim

	EO	DT 	NL 	NL-OP 	TL 	TL-BE 
	No outside trim Exit only	Dummy trim Pull when dogged	Night latch Key retracts latchbolt	Night latch Key retracts latchbolt optional pull required	Thumbturn Key locks & unlocks (use with DT trim)	Thumbturn Blank escutcheon always operable (no cylinder) (use with DT trim)
Product description	9827EO 9927EO	9827DT 9927DT	9827NL 9927NL	9827NL-OP 9927NL-OP	9827TL 9927TL	9827TL-BE 9927TL-BE
Trim description	—	990DT	990NL-R/V	110NL-MD 110NL-WD	374T X 990DT	374T-BE X 990DT
Escutcheon plate size	—	3" x 14 ^{13/16} " x 3 ^{3/32} " (76x360x2mm)	3" x 14 ^{13/16} " x 3 ^{3/32} " (76x360x2mm)	—	1 ^{11/16} " x 7 ^{1/2} " x 7 ^{7/8} " (43x191x22mm)	1 ^{11/16} " x 7 ^{1/2} " x 7 ^{7/8} " (43x191x22mm)
Pull center to center	—	5 ^{1/2} " (140mm)	5 ^{1/2} " (140mm)	—	—	—
Projection	—	2" (51mm)	2" (51mm)	—	3 ^{1/4} " (83mm)	3 ^{1/4} " (83mm)
ANSI function	01	02	03	03	11 or 12	16
Cylinder type	—	—	Rim	Rim	1 ^{1/4} " Mortise	—
Handing	—	—	—	—	—	—
Optional trim	x990EO x996EO	x996K-DT x996L-DT x696DT x697DT	x996K-NL x996L-NL x696NL x697NL			
Optional #425 SNB quantity for device	6	2	2	6	2	2

	L 	L-NL 	L-BE 	L-DT 
	Lever Key locks & unlocks	Lever – night latch Key retracts latchbolt	Lever – blank escutcheon Always operable (no cylinder)	Lever dummy trim pull when dogged
Product description	9827L 9927L	9827L-NL 9927L-NL	9827L-BE 9927L-BE	9827L-DT 9927L-DT
Trim description	996L-R/V*	996L-NL-R/V	996L-BE-R/V*	996L-DT
Escutcheon plate size	2 ^{3/4} " x 10 ^{3/4} " x 2 ^{7/32} " (70x273x21mm)	2 ^{3/4} " x 10 ^{3/4} " x 2 ^{7/32} " (70x273x21mm)	2 ^{3/4} " x 10 ^{3/4} " x 2 ^{7/32} " (70x273x21mm)	2 ^{3/4} " x 10 ^{3/4} " x 2 ^{7/32} " (70x273x21mm)
Pull center to center	—	—	—	—
Projection	2 ^{7/8} " (73mm)	2 ^{7/8} " (73mm)	2 ^{7/8} " (73mm)	2 ^{7/8} " (73mm)
ANSI function	08	03	14	02
Cylinder type	Rim	Rim	—	—
Handing	Handed/Reversible	Handed/Reversible	Handed/Reversible	Handed/Reversible
Optional #425 SNB quantity for device	2	2	2	2

* Electrified lever operation available

Notes

9827-F/9927-F Surface Mounted Vertical Rod Fire Device



9827-F/9927-F Fire exit surface mounted vertical rod device pairs of doors up to 8' x 10' (2438mm x 3048mm), UL listed for fire exit hardware. See page 72 for detailed information on UL listed fire exit hardware label and door opening size information. Devices are ANSI A156.3 – 2001 Grade 1. The 9827-F device has a smooth mechanism case and the 9927-F device has a grooved case. The surface vertical rod device is non-handed except when the following device options are used: SS (signal switch). See opposite page for available outside trim and device functions. Vertical rod and latch guards are available to protect the bottom rod of the exit device from damage by impacts of carts or gurneys passing through doors. Rod and latch guards can be used on hollow metal or tin clad composite fire doors.

Finishes – US3, US4, US10, US26, US26D, US28 & 313. US15 and US32D available with 98 Series only.

Specifications

Device functions	Device ships EO/DT/NL. Field selectable. For TP, K or L remove NL drive screw from device.	
Device lengths	2'	2" (610 mm) Door size (shipped less UL label)
	3'	2'4" to 3' (711mm to 914 mm) Door size
	4'	2'10" to 4' (864 mm to 1219 mm) Door size
Device centerline from finished floor	39 ⁵ / ₈ " (1006 mm)	
Center case dimensions	8" x 2 ³ / ₄ " x 2 ³ / ₈ " (203mm x 70mm x 60mm)	
Mechanism case dimensions	2 ¹ / ₄ " x 2 ¹ / ₄ " (57mm x 57mm)	
Projection	Pushbar neutral – 3 ¹³ / ₁₆ " (97 mm) Pushbar depressed – 3 ¹ / ₁₆ " (78 mm)	
Latch bolt	Deadlocking anti-friction top & bottom bolt, ⁵ / ₈ " (16mm) throw	
Door undercut	1/4" (7mm) recommended	
Top & bottom Latch case	4 1/2" x 2 1/8" x 1 1/2" (114mm x 54mm x 38mm)	
Vertical rods	1/2" square tubing, standard rods accommodate 7' (2134mm) doors. Top rod length: 34 ¹⁵ / ₁₆ " (887mm); Bottom rod length: 31 1/2" (794mm) Extension rods available in 1' (205mm) or 3' (914mm) for doors over 7'. One piece top rod is available for 8' (2438mm) and 10' (3048mm) doors.	
Fasteners & sex bolts (SNB)	Includes screw pack for 1 3/4" (44mm) to 2 1/4" (57mm) thick metal or wood doors, and 325 SNB for top and bottom latch. Optional 425 SNB available.	
Electric options	LX	Latchbolt monitor switch
	RX	Pushpad monitor switch
	RX2	Double pushpad monitor switch
	E	Electric unlocking and locking trim
	EL	Electric latch retraction
	QEL	Quiet electric latch retraction
	SS	Signal switch
	CX	Chexit delayed exit
	ALK	Alarm exit kit
	WP-RX	Waterproof request to exit
	CON	Allegion Connect
Mechanical options	GBK	Glass bead kit
	PN	Pneumatic latch retraction
	LBR	Less bottom rod
	PL	Pullman latch
	WS	Tornado and hurricane tested
	SNB	Sex bolts
	SEC	Security screws
SLM	Special laminate material blocking	
Dogging option	No mechanical dogging. EL and QEL option available	
Strikes	Top – 299F (499F LBR) Dull black, Bottom – 304L - Unfinished	

WS
Windstorm

- Severe weather certified/tested
- FEMA and ICC compliant
- Tornado & hurricane tested

RX
Pushpad monitor switch

- Signals use of an opening
- SPDT switch to monitor pushpad

QEL
Quiet electric latch retraction

- Bolt retraction via switch
- Converts exit door to push-pull operation

ALK
Alarm exit kit

- Unauthorized opening triggers 85-decibel horn
- Set in armed or disarmed mode by key

EL
Electric latch retraction

- Enables remote unlatching
- Alternative to manual dogging

CX
Chexit delayed exit

- Meets NFPA 101 requirements
- Self-contained controls, locking, alarm

E (E996L)
Electrified breakaway lever

- Electrified remote locking/unlocking
- Standard in fail safe condition

LBR
Less bottom rod

- Available with UL Fire Label
- For pairs of vertical rod devices





PN
Pneumatic latch retraction





- For areas where electrical devices banned
- Special linkage for mechanical or pneumatic dogging

CON
Allegion Connectors

- Common connectors to connect various door hardware all the way to the power supply

Standard trim

	EO	DT 	NL 	NL-OP 	TL 	TL-BE 
	No outside trim Exit only	Dummy trim Pull when dogged (not recommended for fire device)	Night latch Key retracts latchbolt	Night latch Key retracts latchbolt optional pull required	Thumbturn Key locks & unlocks (use with DT trim)	Thumbturn Blank escutcheon always operable (no cylinder) (use with DT trim)
Product description	9827EO-F 9927EO-F	— —	9827NL-F 9927NL-F	9827NL-OP-F 9927NL-OP-F	9827TL-F 9927TL-F	9827TL-BE-F 9927TL-BE-F
Trim description	—	990DT	990NL-R/V	110NL-MD 110NL-WD	374T X 990DT	374T-BE X 990DT
Escutcheon plate size	—	3" x 14 ^{13/16"} x 3 ^{3/32"} (76x360x2mm)	3" x 14 ^{13/16"} x 3 ^{3/32"} (76x360x2mm)	—	1 ^{11/16"} x 7 ^{1/2"} x 7 ^{7/8"} (43x191x22mm)	1 ^{11/16"} x 7 ^{1/2"} x 7 ^{7/8"} (43x191x22mm)
Pull center to center	—	5 ^{1/2"} (140mm)	5 ^{1/2"} (140mm)	—	—	—
Projection	—	2" (51mm)	2" (51mm)	—	2" (51mm)	2" (51mm)
ANSI function	01	02	03	03	11 or 12	16
Cylinder type	—	—	Rim	Rim	1 ^{1/4"} Mortise	—
Handing	—	—	—	—	—	—
Optional trim	x990EO x996EO	x996K-DT x996L-DT x696DT x697DT	x996K-NL x996L-NL x696NL x697NL			
Optional #425 SNB quantity for device	6	2	2	6	2	2

	L 	L-NL 	L-BE 	L-DT 
	Lever Key locks & unlocks	Lever – night latch Key retracts latchbolt	Lever – blank escutcheon Always operable (no cylinder)	Lever dummy trim pull when dogged (not recommended for fire device)
Product description	9827L-F 9927L-F	9827L-NL-F 9927L-NL-F	9827L-BE-F 9927L-BE-F	— —
Trim description	996L-R/V*	996L-NL-R/V	996L-BE-R/V*	996L-DT
Escutcheon plate size	2 ^{3/4"} x 10 ^{3/4"} x 2 ^{7/32"} (70x273x21mm)	2 ^{3/4"} x 10 ^{3/4"} x 2 ^{7/32"} (70x273x21mm)	2 ^{3/4"} x 10 ^{3/4"} x 2 ^{7/32"} (70x273x21mm)	2 ^{3/4"} x 10 ^{3/4"} x 2 ^{7/32"} (70x273x21mm)
Pull center to center	—	—	—	—
Projection	2 ^{7/8"} (73mm)	2 ^{7/8"} (73mm)	2 ^{7/8"} (73mm)	2 ^{7/8"} (73mm)
ANSI function	08	03	14	02
Cylinder type	Rim	Rim	—	—
Handing	Handed/Reversible	Handed/Reversible	Handed/Reversible	Handed/Reversible
Optional #425 SNB quantity for device	2	2	2	2

* Electrified lever operation available

Notes

98/99 Electrical options

EL Electric latch retraction

The EL feature allows for the remote unlatching of exit devices. A control station operator can flip a switch to retract the latch bolt and immediately change an exit door to push-pull operation. A powerful, continuous duty solenoid retracts the latch bolt, either for momentary unlatching, or for extended periods of time. The EL feature is an alternative to manual dogging.

If manual hex-key dogging is required, specify HD-EL. If cylinder dogging is required, the standard cylinder dogging is not available, but special center case dogging is available, specify SD-EL. SD-EL is not available on the 9875 or 9975 devices.

EL devices are also useful with automatic door operators, and may be applied to fire-rated applications when under the control of an **automatic fire alarm system**.

UL approved for Class II circuit applications.

The EL option does not include the power transfer from door to frame, the power supply, or the control operator. Refer to EPT-2 power transfer and the PS914 power supply.

The PS914 with the 9002RS option card is the minimum option card required. Other option cards available for other functions, see PS914 power supply for additional information.

Solenoid specifications:

Continuous duty – 24 VDC
Current inrush – 16 Amps
Current holding – 0.3 Amps

Solenoid resistance:

-grn-yel 1.2 – 2.2 OHMS
-grn-org 100 – 150 OHMS

To order, specify:

Standard – use prefix EL, example EL99L.
Hex Key dogging – Use prefix HD-EL, example HD-EL99L
special center case dogging – Use prefix SD-EL, example SD-EL99L

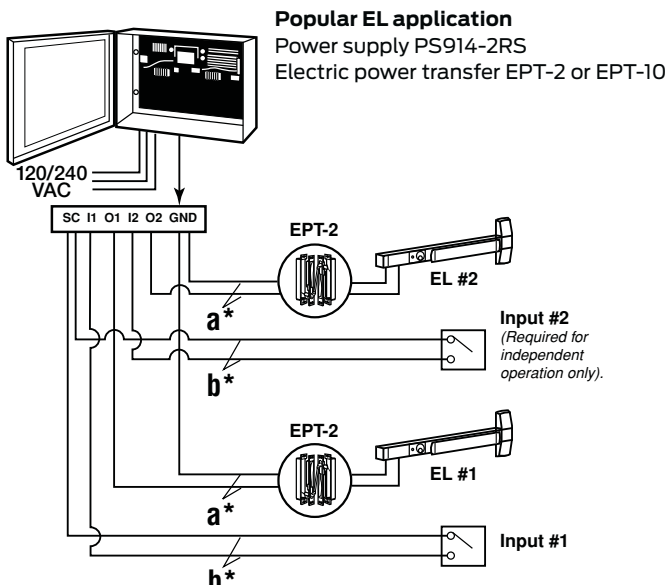

Von Duprin exit device	EL Wire length (feet) ¹	Wire gauge (AWG)
EL 98/99 Rim	0-500	12
	0-300	14
	0-200	16
All other 98/99EL device types	0-250	12
	0-150	14
	0-100	16
Control Switch	0-1200	18

1. Wire lengths include an EPT, Door loop, electric hinge or pivot and are measured one way between the PS914/option board and the device.
2. Table is applicable to devices that have shipped after August 2012.

QEL Quiet electric latch retraction

The QEL feature allows for the remote unlatching of exit devices. A control station operator can flip a switch to retract the latch bolt and immediately change an exit door to push-pull operation. Different than the popular EL, the QEL quiet operation is achieved using an electric drive motor which retracts the latch bolt either momentary unlatching or for extended periods of time. This feature is an alternative to manual dogging.

If cylinder dogging is required, the standard cylinder dogging is not available, but special center case dogging is available, specify

SD-QEL. SD-QEL is not available on the 9875 or 9975 devices.

QEL devices are also useful with automatic door operators, and may be applied to fire-rated applications when under the control of an automatic fire alarm system.

UL approved for Class II circuit applications.

The QEL option does not include the power transfer from door to frame, the power supply, or the control operator. Refer to EPT-2 power transfer and the PS902 or 914 power supply.

The PS902/914 with the 2RS, 4RL or 4R board is the minimum required. Other option boards available for other functions, see PS902/914 power supply for additional information.

QEL Electrical load	
Voltage	24VDC
Current	1.4 A Inrush (0.5 sec.) 0.14 A Holding 2.0 A Calibrate (3 sec. one time)

To order, specify:

Standard – use prefix QEL, example QEL99L.
Special center case dogging – use prefix SD-QEL, example SD-QEL99L

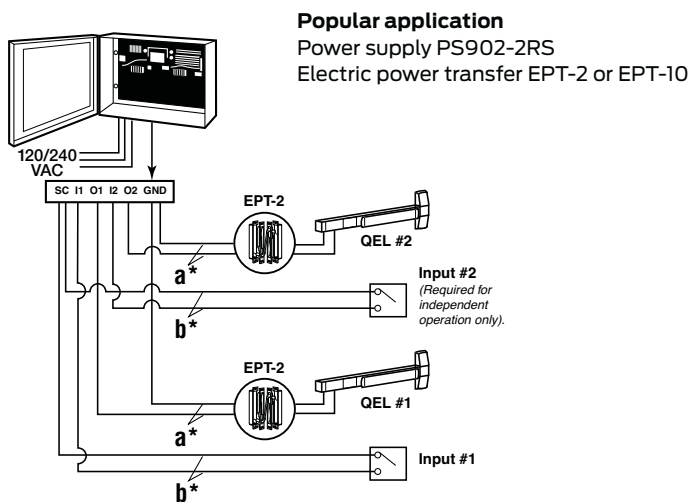

a*	Distance (one-way)	Wire gauge
	200'	18 AWG
	320'	16 AWG
	500'	14 AWG
	800'	12 AWG

b*	Wire selection	Switch wire size
	1200 ft. Max.	18 gauge standard